

LUNA2000-(7, 14, 21)-S1

User Manual

Issue 01
Date 2024-03-27



Copyright © Huawei Digital Power Technologies Co., Ltd. 2024. All rights reserved.

No part of this document may be reproduced or transmitted in any form or by any means without prior written consent of Huawei Digital Power Technologies Co., Ltd.

Trademarks and Permissions



HUAWEI and other Huawei trademarks are the property of Huawei Technologies Co., Ltd.

All other trademarks and trade names mentioned in this document are the property of their respective holders.

Notice

The purchased products, services and features are stipulated by the contract made between Huawei Digital Power Technologies Co., Ltd. and the customer. All or part of the products, services and features described in this document may not be within the purchase scope or the usage scope. Unless otherwise specified in the contract, all statements, information, and recommendations in this document are provided "AS IS" without warranties, guarantees or representations of any kind, either express or implied. The information in this document is subject to change without notice. Every effort has been made in the preparation of this document to ensure accuracy of the contents, but all statements, information, and recommendations in this document do not constitute a warranty of any kind, express or implied.

Huawei Digital Power Technologies Co., Ltd.

Address: Huawei Digital Power Antuoshan Headquarters
Futian, Shenzhen 518043
People's Republic of China

Website: <https://e.huawei.com>

About This Document

Purpose

This document describes the product information, application scenarios, installation, commissioning, maintenance, and technical specifications of the energy storage system (ESS) that consists of the LUNA2000-10KW-C1 Energy Storage Control Unit and the LUNA2000-7-E1 Energy Storage Module.





Intended Audience

This document is intended for:

- Sales engineers
- System engineers
- Technical support engineers
- End users

Symbol Conventions

The symbols that may be found in this manual are defined as follows.

Symbol	Description
	Indicates a hazard with a high level of risk which, if not avoided, will result in death or serious injury.
	Indicates a hazard with a medium level of risk which, if not avoided, could result in death or serious injury.
	Indicates a hazard with a low level of risk which, if not avoided, could result in minor or moderate injury.
	Indicates a potentially hazardous situation which, if not avoided, could result in equipment damage, data loss, performance deterioration, or unanticipated results. NOTICE is used to address practices not related to personal injury.

Symbol	Description
 NOTE	Supplements the important information in the main text. NOTE is used to address information not related to personal injury, equipment damage, and environment deterioration.

Change History

Changes between document issues are cumulative. The latest document issue contains all the changes made in earlier issues.

Issue 01 (2024-03-27)

This issue is the first official release.

Contents

About This Document.....	ii
1 Safety Information.....	1
1.1 Personal Safety.....	2
1.2 Electrical Safety.....	4
1.3 Environment Requirements.....	8
1.4 Mechanical Safety.....	11
1.5 Battery Safety.....	15
2 Product Description.....	20
2.1 Overview.....	20
2.2 Appearance.....	22
2.3 Application Scenarios and Settings.....	25
2.3.1 Networking.....	25
2.3.2 ESS Working Modes.....	27
2.4 Label Description.....	31
2.5 Working Modes.....	35
3 Transportation and Storage.....	36
3.1 Transportation Requirements.....	36
3.2 Storage Requirements.....	39
3.3 Battery Charge.....	40
4 Installing the ESS.....	44
4.1 Pre-installation Check.....	45
4.2 Tools.....	46
4.3 Moving an Energy Storage Module.....	48
4.4 Installation Requirements.....	48
4.5 Installing the ESS.....	49
4.5.1 Floor Mounting.....	50
4.5.2 Wall Mounting.....	52
5 Electrical Connections.....	56
5.1 Preparing Cables.....	58
5.2 Cable Hole on the Decorative Cover.....	59
5.3 Installing a PE Cable.....	59

5.4 Installing DC Input Power Cables.....	61
5.5 Installing Signal Cables.....	62
5.6 Installing Decorative Covers.....	65
6 Power-On and Commissioning.....	67
6.1 Check Before Power-On.....	67
6.2 System Power-On.....	68
6.3 ESS Commissioning (Smart Dongle Networking).....	71
6.3.1 Deploying a New Plant.....	71
6.3.2 Setting ESS Parameters.....	72
6.3.3 Querying the ESS Status.....	75
6.3.4 Forced Charge/Discharge.....	76
6.3.5 ESS Upgrade.....	77
6.3.6 Peak Shaving.....	78
6.4 ESS Commissioning (EMMA Networking).....	79
6.4.1 Deploying a New Plant.....	80
6.4.2 Setting ESS Parameters.....	81
6.4.3 Querying the ESS Status.....	85
6.4.4 Forced Charge/Discharge.....	85
6.4.5 ESS Upgrade.....	87
6.4.6 Peak Shaving.....	88
7 ESS Maintenance.....	90
7.1 System Power-Off.....	91
7.2 Routine Maintenance.....	91
7.3 Troubleshooting.....	92
7.4 ESS Replacement-1.....	105
7.5 Charge Requirements for Batteries in Low SOC.....	110
7.6 Battery Health Check.....	111
8 Emergency Handling.....	114
9 Technical Specifications.....	119
A Connecting the Inverter on the App.....	121
B Connecting the EMMA on the App.....	125
C Preconfigured Certificate Disclaimer.....	129
D Acronyms and Abbreviations.....	130

1 Safety Information

Statement

Before transporting, storing, installing, operating, using, and/or maintaining the equipment, read this document, strictly follow the instructions provided herein, and follow all the safety instructions on the equipment and in this document. In this document, "equipment" refers to the products, software, components, spare parts, and/or services related to this document; "the Company" refers to the manufacturer (producer), seller, and/or service provider of the equipment; "you" refers to the entity that transports, stores, installs, operates, uses, and/or maintains the equipment.

The **Danger, Warning, Caution, and Notice** statements described in this document do not cover all the safety precautions. You also need to comply with relevant international, national, or regional standards and industry practices. **The Company shall not be liable for any consequences that may arise due to violations of safety requirements or safety standards concerning the design, production, and usage of the equipment.**

The equipment shall be used in an environment that meets the design specifications. Otherwise, the equipment may be faulty, malfunctioning, or damaged, which is not covered under the warranty. The Company shall not be liable for any property loss, personal injury, or even death caused thereby.

Comply with applicable laws, regulations, standards, and specifications during transportation, storage, installation, operation, use, and maintenance.

Do not perform reverse engineering, decompilation, disassembly, adaptation, implantation, or other derivative operations on the equipment software. Do not study the internal implementation logic of the equipment, obtain the source code of the equipment software, violate intellectual property rights, or disclose any of the performance test results of the equipment software.

The Company shall not be liable for any of the following circumstances or their consequences:

- The equipment is damaged due to force majeure such as earthquakes, floods, volcanic eruptions, debris flows, lightning strikes, fires, wars, armed conflicts, typhoons, hurricanes, tornadoes, and other extreme weather conditions.
- The equipment is operated beyond the conditions specified in this document.

- The equipment is installed or used in environments that do not comply with international, national, or regional standards.
- The equipment is installed or used by unqualified personnel.
- You fail to follow the operation instructions and safety precautions on the product and in the document.
- You remove or modify the product or modify the software code without authorization.
- You or a third party authorized by you cause the equipment damage during transportation.
- The equipment is damaged due to storage conditions that do not meet the requirements specified in the product document.
- You fail to prepare materials and tools that comply with local laws, regulations, and related standards.
- The equipment is damaged due to your or a third party's negligence, intentional breach, gross negligence, or improper operations, or other reasons not related to the Company.

1.1 Personal Safety

 **DANGER**

Ensure that power is off during installation. Do not install or remove a cable with power on. Transient contact between the core of the cable and the conductor will cause electric arcs, sparks, fire, or explosion, which may result in personal injury.

 **DANGER**

Non-standard and improper operations on the energized equipment may cause fire, electric shocks, or explosion, resulting in property damage, personal injury, or even death.

 **DANGER**

Before operations, remove conductive objects such as watches, bracelets, bangles, rings, and necklaces to prevent electric shocks.

 **DANGER**

During operations, use dedicated insulated tools to prevent electric shocks or short circuits. The dielectric withstanding voltage level must comply with local laws, regulations, standards, and specifications.

⚠ DANGER

During operations, wear personal protective equipment such as protective clothing, insulated shoes, goggles, safety helmets, and insulated gloves.

Figure 1-1 Personal protective equipment

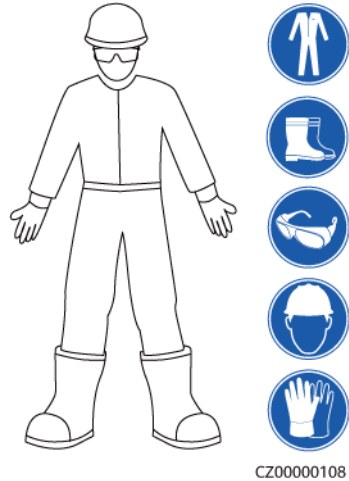

General Requirements

- Do not stop protective devices. Pay attention to the warnings, cautions, and related precautionary measures in this document and on the equipment.
- If there is a likelihood of personal injury or equipment damage during operations, immediately stop, report the case to the supervisor, and take feasible protective measures.
- Do not power on the equipment before it is installed or confirmed by professionals.
- Do not touch the power supply equipment directly or with conductors such as damp objects. Before touching any conductor surface or terminal, measure the voltage at the contact point to ensure that there is no risk of electric shock.
- Do not touch operating equipment because the enclosure is hot.
- In the case of a fire, immediately leave the building or the equipment area and activate the fire alarm or call emergency services. Do not enter the affected building or equipment area under any circumstances.

Personnel Requirements

- Only professionals and trained personnel are allowed to operate the equipment.
 - Professionals: personnel who are familiar with the working principles and structure of the equipment, trained or experienced in equipment operations and are clear of the sources and degree of various potential hazards in equipment installation, operation, maintenance
 - Trained personnel: personnel who are trained in technology and safety, have required experience, are aware of possible hazards on themselves in

certain operations, and are able to take protective measures to minimize the hazards on themselves and other people

- Personnel who plan to install or maintain the equipment must receive adequate training, be able to correctly perform all operations, and understand all necessary safety precautions and local relevant standards.
- Only qualified professionals or trained personnel are allowed to install, operate, and maintain the equipment.
- Only qualified professionals are allowed to remove safety facilities and inspect the equipment.
- Personnel who will perform special tasks such as electrical operations, working at heights, and operations of special equipment must possess the required local qualifications.
- Only authorized professionals are allowed to replace the equipment or components (including software).
- Only personnel who need to work on the equipment are allowed to access the equipment.

1.2 Electrical Safety

 **DANGER**

Before connecting cables, ensure that the equipment is intact. Otherwise, electric shocks or fire may occur.

 **DANGER**

Non-standard and improper operations may result in fire or electric shocks.

 **DANGER**

Prevent foreign matter from entering the equipment during operations. Otherwise, equipment damage, load power derating, power failure, or personal injury may occur.

 **WARNING**

For the equipment that needs to be grounded, install the ground cable first when installing the equipment and remove the ground cable last when removing the equipment.

General Requirements

- Follow the procedures described in the document for installation, operation, and maintenance. Do not reconstruct or alter the equipment, add components, or change the installation sequence without permission.
- Obtain approval from the national or local electric utility company before connecting the equipment to the grid.
- Observe the power plant safety regulations, such as the operation and work ticket mechanisms.
- Install temporary fences or warning ropes and hang "No Entry" signs around the operation area to keep unauthorized personnel away from the area.
- Before installing or removing power cables, turn off the switches of the equipment and its upstream and downstream switches.
- If any liquid is detected inside the equipment, disconnect the power supply immediately and do not use the equipment.
- Before performing operations on the equipment, check that all tools meet the requirements and record the tools. After the operations are complete, collect all of the tools to prevent them from being left inside the equipment.
- Before installing power cables, check that cable labels are correct and cable terminals are insulated.
- When installing the equipment, use a torque tool of a proper measurement range to tighten the screws. When using a wrench to tighten the screws, ensure that the wrench does not tilt and the torque error does not exceed 10% of the specified value.
- Ensure that bolts are tightened with a torque tool and marked in red and blue after double-check. Installation personnel mark tightened bolts in blue. Quality inspection personnel confirm that the bolts are tightened and then mark them in red. (The marks must cross the edges of the bolts.)

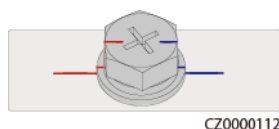

- After the installation is complete, ensure that protective cases, insulation tubes, and other necessary items for all electrical components are in position to avoid electric shocks.
- If the equipment has multiple inputs, disconnect all the inputs before operating the equipment.
- Before maintaining a downstream electrical or power distribution device, turn off the output switch on the power supply equipment.
- During equipment maintenance, attach "Do not switch on" labels near the upstream and downstream switches or circuit breakers as well as warning signs to prevent accidental connection. The equipment can be powered on only after troubleshooting is complete.
- If fault diagnosis and troubleshooting need to be performed after power-off, take the following safety measures: Disconnect the power supply. Check whether the equipment is live. Install a ground cable. Hang warning signs and set up fences.
- Do not open equipment panels.

- Check equipment connections periodically, ensuring that all screws are securely tightened.
- Only qualified professionals can replace a damaged cable.
- Do not scrawl, damage, or block any labels or nameplates on the equipment. Promptly replace labels that have worn out.
- Do not use solvents such as water, alcohol, or oil to clean electrical components inside or outside of the equipment.

Grounding

- Ensure that the grounding impedance of the equipment complies with local electrical standards.
- Ensure that the equipment is connected permanently to the protective ground. Before operating the equipment, check its electrical connection to ensure that it is reliably grounded.
- Do not work on the equipment in the absence of a properly installed ground conductor.
- Do not damage the ground conductor.
- For the equipment that uses a three-pin socket, ensure that the ground terminal in the socket is connected to the protective ground point.
- If high touch current may occur on the equipment, ground the protective ground terminal on the equipment enclosure before connecting the power supply; otherwise, electric shock as a result of touch current may occur.

Cabling Requirements

- When selecting, installing, and routing cables, follow local safety regulations and rules.
- When routing power cables, ensure that there is no coiling or twisting. Do not join or weld power cables. If necessary, use a longer cable.
- Ensure that all cables are properly connected and insulated, and meet specifications.
- Ensure that the slots and holes for routing cables are free from sharp edges, and that the positions where cables are routed through pipes or cable holes are equipped with cushion materials to prevent the cables from being damaged by sharp edges or burrs.
- Ensure that cables of the same type are bound together neatly and straight and that the cable sheath is intact. When routing cables of different types, ensure that they are away from each other without entanglement and overlapping.
- When cable connection is completed or paused for a short period of time, seal the cable holes with sealing putty immediately to prevent small animals or moisture from entering.
- Secure buried cables using cable supports and cable clips. Ensure that the cables in the backfill area are in close contact with the ground to prevent cable deformation or damage during backfilling.
- If the external conditions (such as the cable layout or ambient temperature) change, verify the cable usage in accordance with the IEC-60364-5-52 or local laws and regulations. For example, check that the current-carrying capacity meets requirements.

- When routing cables, reserve at least 30 mm clearance between the cables and heat-generating components or areas. This prevents deterioration or damage to the cable insulation layer.
- When the temperature is low, violent impact or vibration may damage the plastic cable sheathing. To ensure safety, comply with the following requirements:
 - Cables can be laid or installed only when the temperature is higher than 0°C. Handle cables with caution, especially at a low temperature.
 - Cables stored at below 0°C must be stored at room temperature for more than 24 hours before they are laid out.
- Do not perform any improper operations, for example, dropping cables directly from a vehicle. Otherwise, the cable performance may deteriorate due to cable damage, which affects the current-carrying capacity and temperature rise.

ESD

NOTICE

The static electricity generated by human bodies may damage the electrostatic-sensitive components on boards, for example, the large-scale integrated (LSI) circuits.

- When touching the equipment and handling boards, modules with exposed circuit boards, or application-specific integrated circuits (ASICs), observe ESD protection regulations and wear ESD clothing and ESD gloves or a well-grounded ESD wrist strap.

Figure 1-2 Wearing an ESD wrist strap

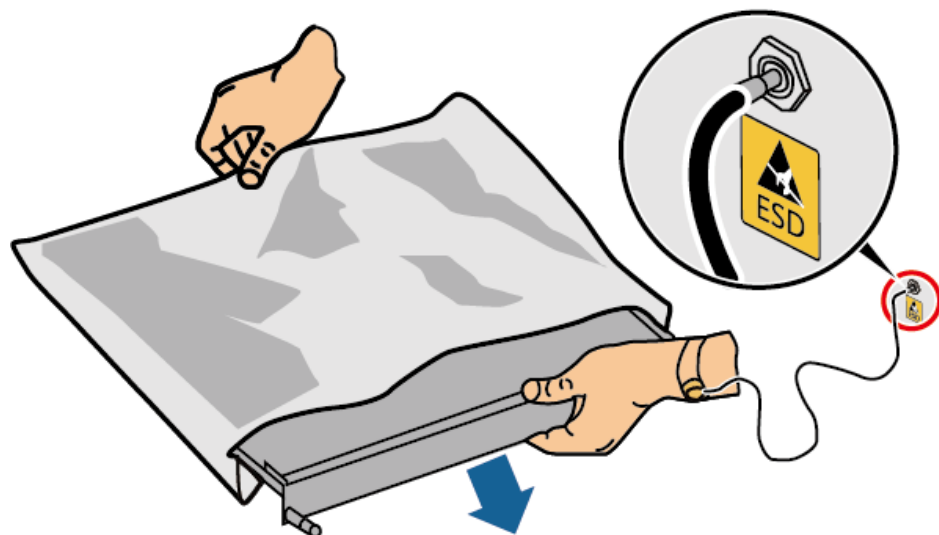

DC15000001

- When holding a board or a module with exposed circuit boards, hold its edge without touching any components. Do not touch the components with bare hands.

- Package boards or modules with ESD packaging materials before storing or transporting them.

1.3 Environment Requirements

 **DANGER**

Do not expose the equipment to flammable or explosive gas or smoke. Do not perform any operation on the equipment in such environments.

 **DANGER**

Do not store any flammable or explosive materials in the equipment area.

 **DANGER**

Do not place the equipment near heat sources or fire sources, such as smoke, candles, heaters, or other heating devices. Overheat may damage the equipment or cause a fire.

 **WARNING**

Install the equipment in an area far away from liquids. Do not install it under areas prone to condensation, such as under water pipes and air exhaust vents, or areas prone to water leakage, such as air conditioner vents, ventilation vents, or feeder windows of the equipment room. Ensure that no liquid enters the equipment to prevent faults or short circuits.

 **WARNING**

To prevent damage or fire due to high temperature, ensure that the ventilation vents or heat dissipation systems are not obstructed or covered by other objects while the equipment is running.

General Requirements

- The installation and usage environment must meet relevant international, national, and local standards for lithium batteries, and are in accordance with the local laws and regulations. The user is obliged to protect the ESS against fire or other hazards.
- Keep the ESS out of the reach of children and away from daily working or living areas, including but not limited to the following areas: studio, bedroom, lounge, living room, music room, kitchen, study, game room, home theater, sunroom, toilet, bathroom, laundry, and attic.

- When installing the ESS in a garage, keep it clear of the drive path. It is recommended that the ESS be mounted on the wall higher than the bumper to prevent collision.
- Do not install the ESS in places that are enclosed, unventilated, without proper fire fighting facilities, or difficult for firefighters to access. Do not place flammable or explosive materials around the ESS. It is recommended that the ESS be mounted on a wall to avoid contact with water.
- Install the ESS in a sheltered place or install an awning over it to avoid direct sunlight or rain.
- For areas prone to natural disasters such as floods, debris flows, earthquakes, and typhoons, take corresponding precautions for installation.
- Do not install the ESS in an easily accessible position because the temperature of the enclosure and heat sink is high when the ESS is running.
- Do not install the ESS on a moving object, such as ship, train, or car.
- Ensure that the equipment is stored in a clean, dry, and well ventilated area with proper temperature and humidity and is protected from dust and condensation.
- Keep the installation and operating environments of the equipment within the allowed ranges. Otherwise, its performance and safety will be compromised.
- Do not install, use, or operate outdoor equipment and cables (including but not limited to moving equipment, operating equipment and cables, inserting connectors to or removing connectors from signal ports connected to outdoor facilities, working at heights, performing outdoor installation, and opening doors) in harsh weather conditions such as lightning, rain, snow, and level 6 or stronger wind.
- Do not install the equipment in an environment with direct sunlight, dust, smoke, volatile or corrosive gases, infrared and other radiations, organic solvents, or salty air.
- Do not install the equipment in an environment with conductive metal or magnetic dust.
- Do not install the equipment in an area conducive to the growth of microorganisms such as fungus or mildew.
- Do not install the equipment in an area with strong vibration, noise, or electromagnetic interference.
- Ensure that the site complies with local laws, regulations, and related standards.
- Ensure that the ground in the installation environment is solid, free from spongy or soft soil, and not prone to subsidence. The site must not be located in a low-lying land prone to water or snow accumulation, and the horizontal level of the site must be above the highest water level of that area in history.
- Do not install the equipment in a position that may be submerged in water.
- If the equipment is installed in a place with abundant vegetation, in addition to routine weeding, harden the ground underneath the equipment using cement or gravel.
- Do not install the equipment outdoors in salt-affected areas because it may be corroded. A salt-affected area refers to the region within 500 m of the coast or prone to sea breeze. Regions prone to sea breeze vary with weather

conditions (such as typhoons and monsoons) or terrains (such as dams and hills).

- Before installation, operation, and maintenance, clean up any water, ice, snow, or other foreign objects on the top of the equipment.
- When installing the equipment, ensure that the installation surface is solid enough to bear the weight of the equipment.
- After installing the equipment, remove the packing materials such as cartons, foam, plastics, and cable ties from the equipment area.

Figure 1-3 Installation environment

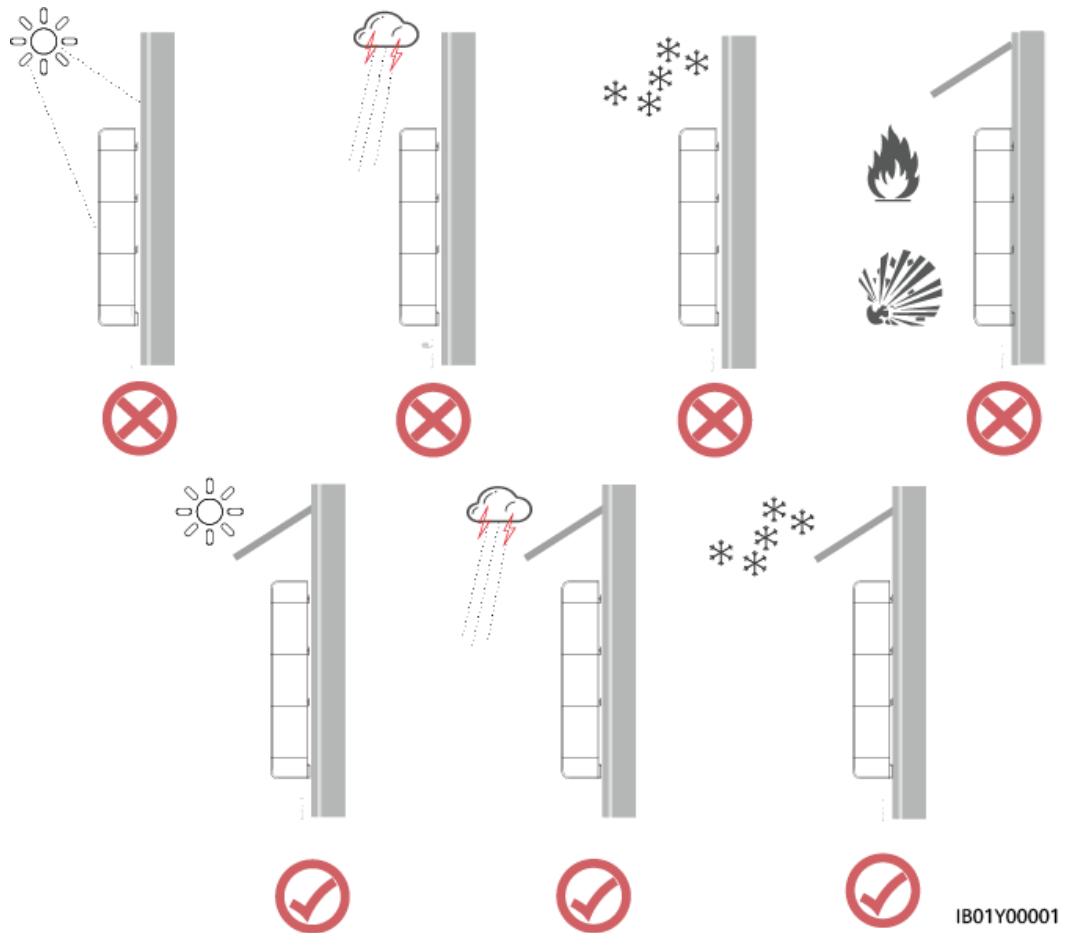

NOTE

- The operation and service life of the battery depend on the operating temperature. Install the battery at a temperature equal to the ambient temperature or in a better environment.
- The operating temperature of the LUNA2000 ranges from -20°C to $+55^{\circ}\text{C}$. If the LUNA2000 is installed in a cold environment, the built-in thermal control system starts to heat the battery to achieve better performance. The heating process consumes rechargeable power, which reduces the system energy efficiency in cold weather.

1.4 Mechanical Safety

DANGER

When working at heights, wear a safety helmet and safety harness or waist belt and fasten it to a solid structure. Do not mount it on an insecure moveable object or metal object with sharp edges. Make sure that the hooks will not slide off.

WARNING

Ensure that all necessary tools are ready and inspected by a professional organization. Do not use tools that have signs of scratches or fail to pass the inspection or whose inspection validity period has expired. Ensure that the tools are secure and not overloaded.

WARNING

Do not drill holes into the equipment. Doing so may affect the sealing performance and electromagnetic containment of the equipment and damage components or cables inside. Metal shavings from drilling may short-circuit boards inside the equipment.

General Requirements

- Repaint any paint scratches caused during equipment transportation or installation in a timely manner. Equipment with scratches must not be exposed for an extended period of time.
- Do not perform operations such as arc welding and cutting on the equipment without evaluation by the Company.
- Do not install other devices on the top of the equipment without evaluation by the Company.
- When performing operations over the top of the equipment, take measures to protect the equipment against damage.
- Use correct tools and operate them in the correct way.

Moving Heavy Objects

- Be cautious to prevent injury when moving heavy objects.



< 18 kg
(< 40 lbs)



18–32 kg
(40–70 lbs)



32–55 kg
(70–121 lbs)

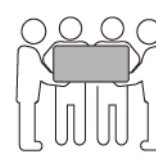

55–68 kg
(121–150 lbs)



> 68 kg
(> 150 lbs)

CZ0000110

- If multiple persons need to move a heavy object together, determine the manpower and work division with consideration of height and other conditions to ensure that the weight is equally distributed.
- If two persons or more move a heavy object together, ensure that the object is lifted and landed simultaneously and moved at a uniform pace under the supervision of one person.
- Wear personal protective gears such as protective gloves and shoes when manually moving the equipment.
- To move an object by hand, approach to the object, squat down, and then lift the object gently and stably by the force of the legs instead of your back. Do not lift it suddenly or turn your body around.
- Do not quickly lift a heavy object above your waist. Place the object on a workbench that is half-waist high or any other appropriate place, adjust the positions of your palms, and then lift it.
- Move a heavy object stably with balanced force at an even and low speed. Put down the object stably and slowly to prevent any collision or drop from scratching the surface of the equipment or damaging the components and cables.
- When moving a heavy object, be aware of the workbench, slope, staircase, and slippery places. When moving a heavy object through a door, ensure that the door is wide enough to move the object and avoid bumping or injury.
- When transferring a heavy object, move your feet instead of turning your waist around. When lifting and transferring a heavy object, ensure that your feet point to the target direction of movement.
- When transporting the equipment using a pallet truck or forklift, ensure that the tynes are properly positioned so that the equipment does not topple. Before moving the equipment, secure it to the pallet truck or forklift using ropes. When moving the equipment, assign dedicated personnel to take care of it.
- Choose sea or roads in good conditions for transportation. Do not transport the equipment by railway or air. Avoid tilt or jolt during transportation.

Working at Heights

- Any operations performed 2 m or higher above the ground shall be supervised properly.
- Only trained and qualified personnel are allowed to work at heights.
- Do not work at heights when steel pipes are wet or other risky situations exist. After the preceding conditions no longer exist, the safety owner and relevant technical personnel need to check the involved equipment. Operators can begin working only after safety is confirmed.
- Set a restricted area and prominent signs for working at heights to warn away irrelevant personnel.
- Set guard rails and warning signs at the edges and openings of the area involving working at heights to prevent falls.
- Do not pile up scaffolding, springboards, or other objects on the ground under the area involving working at heights. Do not allow people to stay or pass under the area involving working at heights.

- Carry operation machines and tools properly to prevent equipment damage or personal injury caused by falling objects.
- Personnel involving working at heights are not allowed to throw objects from the height to the ground, or vice versa. Objects shall be transported by slings, hanging baskets, aerial work platforms, or cranes.
- Do not perform operations on the upper and lower layers at the same time. If unavoidable, install a dedicated protective shelter between the upper and lower layers or take other protective measures. Do not pile up tools or materials on the upper layer.
- Dismantle the scaffolding from top down after finishing the job. Do not dismantle the upper and lower layers at the same time. When removing a part, ensure that other parts will not collapse.
- Ensure that personnel working at heights strictly comply with the safety regulations. The Company is not responsible for any accident caused by violation of the safety regulations on working at heights.
- Behave cautiously when working at heights. Do not rest at heights.

Using Ladders

- Use wooden or insulated ladders when you need to perform live-line working at heights.
- Platform ladders with protective rails are preferred. Single ladders are not recommended.
- Before using a ladder, check that it is intact and confirm its load bearing capacity. Do not overload it.
- Ensure that the ladder is securely positioned and held firm.



CZ00000107

- When climbing up the ladder, keep your body stable and your center of gravity between the side rails, and do not overreach to the sides.
- When a step ladder is used, ensure that the pull ropes are secured.
- If a single ladder is used, the recommended angle for the ladder against the floor is 75 degrees, as shown in the following figure. A square can be used to measure the angle.

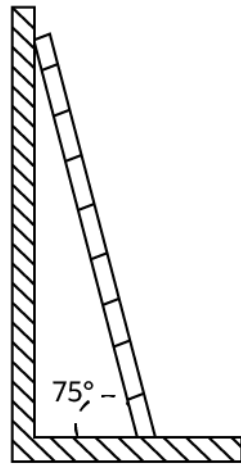

PI02SC0008

- If a single ladder is used, ensure that the wider end of the ladder is at the bottom, and take protective measures to prevent the ladder from sliding.
- If a single ladder is used, do not climb higher than the fourth rung from the top.
- If you use a single ladder to climb up to a platform, ensure that the ladder is at least 1 m higher than the platform.

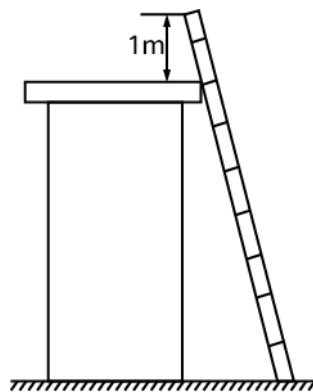

PI02SC0009

Drilling Holes

- Obtain consent from the customer and contractor before drilling holes.
- Wear protective equipment such as safety goggles and protective gloves when drilling holes.
- To avoid short circuits or other risks, do not drill holes into buried pipes or cables.
- When drilling holes, protect the equipment from shavings. After drilling, clean up any shavings.

1.5 Battery Safety

 **DANGER**

Do not connect the positive and negative poles of a battery together. Otherwise, the battery may be short-circuited. Battery short circuits can generate high instantaneous current and releases a large amount of energy, which may cause battery leakage, smoke, flammable gas release, thermal runaway, fire, or explosion. To avoid battery short circuits, do not maintain batteries with power on.

 **DANGER**

Do not expose batteries at high temperatures or around heat sources, such as scorching sunlight, fire sources, transformers, and heaters. Battery overheating may cause leakage, smoke, flammable gas release, thermal runaway, fire, or explosion.

 **DANGER**

Protect batteries from mechanical vibration, falling, collision, punctures, and strong impact. Otherwise, the batteries may be damaged or catch fire.

 **DANGER**

To avoid leakage, smoke, flammable gas release, thermal runaway, fire, or explosion, do not disassemble, alter, or damage batteries, for example, insert foreign objects into batteries, squeeze batteries, or immerse batteries in water or other liquids.

 **DANGER**

Do not touch battery terminals with other metal objects, which may cause heat or electrolyte leakage.

 **DANGER**

There is a risk of fire or explosion if the model of the battery in use or used for replacement is incorrect. Use a battery of the model recommended by the manufacturer.

 **DANGER**

Battery electrolyte is toxic and volatile. Do not get contact with leaked liquids or inhale gases in the case of battery leakage or odor. In such cases, stay away from the battery and contact professionals immediately. Professionals must wear safety goggles, rubber gloves, gas masks, and protective clothing, power off the equipment, remove the battery, and contact technical engineers.

 **DANGER**

A battery is an enclosed system and will not release any gases under normal operations. If a battery is improperly treated, for example, burnt, needle-pricked, squeezed, struck by lightning, overcharged, or subject to other adverse conditions that may cause battery thermal runaway, the battery may be damaged or an abnormal chemical reaction may occur inside the battery, resulting in electrolyte leakage or production of gases such as CO and H₂. To prevent fire or device corrosion, ensure that flammable gas is properly exhausted.

 **DANGER**

The gas generated by a burning battery may irritate your eyes, skin, and throat. Take protective measures promptly.

 **WARNING**

Install batteries in a dry area. Do not install them under areas prone to water leakage, such as air conditioner vents, ventilation vents, feeder windows of the equipment room, or water pipes. Ensure that no liquid enters the equipment to prevent faults or short circuits.

 **WARNING**

Before unpacking, storage, and transportation, ensure that the packing cases are intact and the batteries are correctly placed according to the labels on the packing cases. Do not place a battery upside down or vertically, lay it on one side, or tilt it. Stack the batteries according to the stacking requirements on the packing cases. Ensure that the batteries do not fall or get damaged. Otherwise, they will need to be scrapped.

 **WARNING**

After unpacking batteries, place them in the required direction. Do not place a battery upside down or vertically, lay it on one side, tilt it, or stack it. Ensure that the batteries do not fall or get damaged. Otherwise, they will need to be scrapped.

 **WARNING**

Tighten the screws on copper bars or cables to the torque specified in this document. Periodically confirm whether the screws are tightened, check for rust, corrosion, or other foreign objects, and clean them up if any. Loose screw connections will result in excessive voltage drops and batteries may catch fire when the current is high.

 **WARNING**

After batteries are discharged, charge them in time to avoid damage due to overdischarge.

Statement

The Company shall not be liable for any battery damage, personal injury, death, property loss, and/or other consequences caused by the following reasons:

- Force majeure such as earthquakes, floods, volcanic eruptions, debris flows, lightning strikes, fires, wars, armed conflicts, typhoons, hurricanes, tornadoes, and other extreme weather conditions
- The battery warranty period has expired. You are advised not to use a battery whose warranty period has expired, as this poses safety risks.
- Actions that do not follow instructions in the user manual or direct advice from the Company, including but not limited to the following scenarios:
 - The onsite equipment operating environment or external power parameters do not meet the environment requirements for normal operation, for example, the actual operating temperature of batteries is too high or too low, or the power grid is unstable and experiences outages frequently.
 - Batteries are dropped or incorrectly operated or connected.
 - Batteries are overdischarged due to delayed acceptance or power-on after battery installation.
 - Battery running parameters are incorrectly set.
 - Different types of batteries, for example, batteries of different brands or rated capacities, or old and new batteries, are used together without prior approval from the Company.
 - Different types of batteries, for example, batteries of different brands or rated capacities, are used together without prior approval from the Company.
 - Batteries are frequently overdischarged due to improper battery maintenance.
 - Battery use scenarios are changed without prior approval from the Company.
 - Battery maintenance is not performed according to the instructions in the user manual, for example, failing to check battery terminals regularly.

- Batteries are not transported, stored, or charged according to the instructions in the user manual.
- Instructions from the Company are not followed during battery relocation or reinstallation.
- The battery warranty period has expired. You are advised not to use a battery whose warranty period has expired, as this poses safety risks.

General Requirements

NOTICE

To ensure battery safety and battery management accuracy, use batteries provided by the Company. The Company is not responsible for any faults of batteries not provided by it.

- Before installing, operating, and maintaining batteries, read the battery manufacturer's instructions and comply with their requirements. The safety precautions specified in this document are highly important and require special attention. For additional safety precautions, see the instructions provided by the battery manufacturer.
- Use batteries within the specified temperature range. When the ambient temperature of the batteries is lower than the allowed range, do not charge the batteries to prevent internal short circuits caused during low-temperature charging.
- Before unpacking batteries, check whether the packaging is intact. Do not use batteries with damaged packaging. If any damage is found, notify the carrier and manufacturer immediately.
- Power on batteries within 24 hours after unpacking. If the batteries cannot be powered on in time, put them in the original packaging and place them in a dry indoor environment without corrosive gases. During later maintenance, ensure that the power-off time does not exceed 24 hours.
- Do not use a damaged battery (such as damage caused when a battery is dropped, bumped, bulged, or dented on the enclosure), because the damage may cause electrolyte leakage or flammable gas release. In the case of electrolyte leakage or structural deformation, contact the installer or professional O&M personnel immediately to remove or replace the battery. Do not store the damaged battery near other devices or flammable materials and keep it away from non-professionals.
- Before working on a battery, ensure that there is no irritant or scorched smell around the battery.
- When installing batteries, do not place installation tools, metal parts, or sundries on the batteries. After the installation is complete, clean up the objects on the batteries and the surrounding area.
- If batteries are exposed to water accidentally, do not install them. Instead, transport the batteries to a safe isolation point and dispose of them in a timely manner.
- Before installing a battery pack, check that its enclosure is not deformed or damaged.

- Check whether the positive and negative battery terminals are grounded unexpectedly. If so, disconnect the battery terminals from the ground.
- Do not perform welding or grinding work around batteries to prevent fire caused by electric sparks or arcs.
- If batteries are left unused for a long period of time, store and charge them according to the battery requirements.
- Do not charge or discharge batteries by using a device that does not comply with local laws and regulations.
- Keep the battery loop disconnected during installation and maintenance.
- Monitor damaged batteries during storage for signs of smoke, flame, electrolyte leakage, or heat.
- If a battery is faulty, its surface temperature may be high. Do not touch the battery to avoid scalds.
- Do not stand on, lean on, or sit on the top of the equipment.
- In backup power scenarios, do not use the batteries for the following situations:
 - Medical devices substantially important to human life
 - Control equipment such as trains and elevators, as this may cause personal injury
 - Computer systems of social and public importance
 - Locations near medical devices
 - Other devices similar to those described above

Short-Circuit Protection

- When installing and maintaining batteries, wrap the exposed cable terminals on the batteries with insulation tape.
- Avoid foreign objects (such as conductive objects, screws, and liquids) from entering a battery, as this may cause short circuits.

Recycling

- Dispose of waste batteries in accordance with local laws and regulations. Do not dispose of batteries as household waste. Improper disposal of batteries may result in environmental pollution or an explosion.
- If a battery leaks or is damaged, contact technical support or a battery recycling company for disposal.
- If batteries are out of service life, contact a battery recycling company for disposal.
- Do not expose waste batteries to high temperatures or direct sunlight.
- Do not place waste batteries in environments with high humidity or corrosive substances.
- Do not use faulty batteries. Contact a battery recycling company to scrap them as soon as possible to avoid environmental pollution.

2 Product Description

2.1 Overview

Functions

The LUNA2000 ESS consists of an Energy Storage Control Unit and Energy Storage Modules (also referred to as battery expansion modules or battery packs). It stores and releases electricity as required by a PV system, enabling charge and discharge management of a residential PV+ESS system. The Energy Storage Control Unit connects to the energy storage terminals (BAT+ and BAT-) of an inverter. The input and output ports of the ESS are high-voltage DC ports.

- ESS charge: When the PV energy is sufficient for loads, the ESS stores the surplus PV energy from the inverter.
- ESS discharge: When the PV energy is insufficient, the ESS supplies power to loads through the inverter.

Model Description

- The model of the LUNA2000 ESS is LUNA2000-7/14/21-S1.

Figure 2-1 Model number

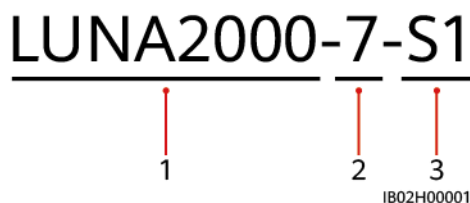

Table 2-1 Model description

No.	Meaning	Description
1	Product	LUNA2000: residential energy storage system

No.	Meaning	Description
2	Energy level	An Energy Storage Module has a capacity of 6.9 kWh. The ESS supports capacity expansion with a maximum of three Energy Storage Modules. The ESS offers the following energy levels: 7: 6.9 kWh 14: 13.8 kWh 21: 20.7 kWh
3	Design code	S1: product series of the ESS

- The model of the Energy Storage Control Unit in the LUNA2000 ESS is LUNA2000-10KW-C1.

Figure 2-2 Model number

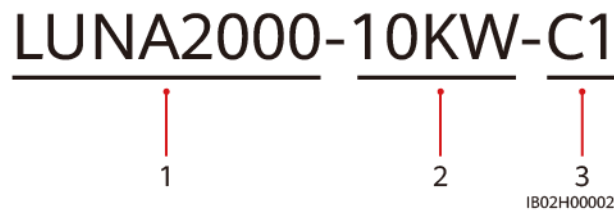

Table 2-2 Model description

No.	Meaning	Description
1	Product	LUNA2000: residential energy storage system
2	Power level	10KW: The power level is 10.5 kW.
3	Design code	C1: product series of the Energy Storage Control Unit

- The model of the Energy Storage Module in the LUNA2000 ESS is LUNA2000-7-E1.

Figure 2-3 Model number

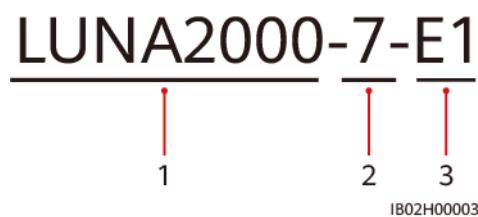

Table 2-3 Model description

No.	Meaning	Description
1	Product	LUNA2000: residential energy storage system
2	Energy level	7: The capacity of an Energy Storage Module is 6.9 kWh.
3	Design code	E1: product series of the Energy Storage Module

Battery Capacity Description

- The ESS supports capacity expansion with a maximum of three Energy Storage Modules. An Energy Storage Module has a capacity of 6.9 kWh.

Figure 2-4 Capacity expansion with Energy Storage Modules

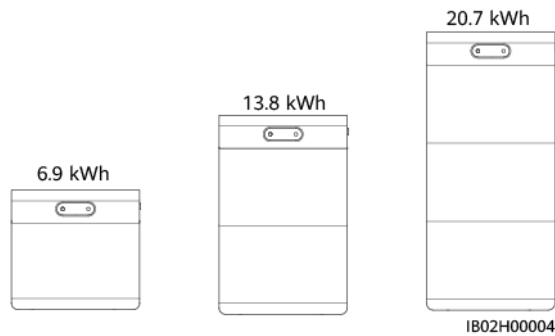

- A maximum of two ESSs can be connected in parallel for capacity expansion.

Figure 2-5 Parallel connection

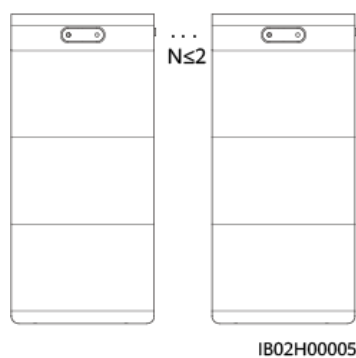

2.2 Appearance

ESS Appearance

This section describes the appearance of the entire ESS.

Figure 2-6 ESS appearance

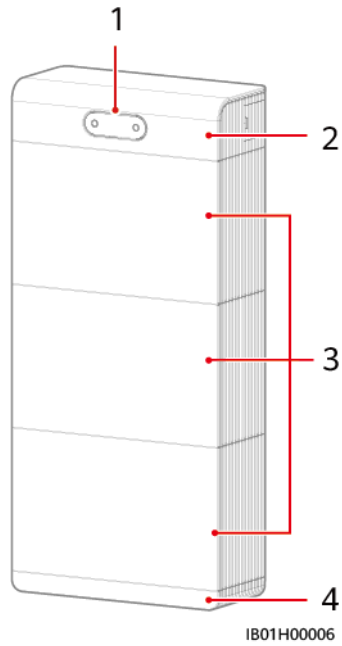

(1) LED indicators

(2) Energy Storage Control Unit

(3) Energy Storage Modules

(4) Floor-mount base

Energy Storage Control Unit

The power of the Energy Storage Control Unit is 10.5 kW.

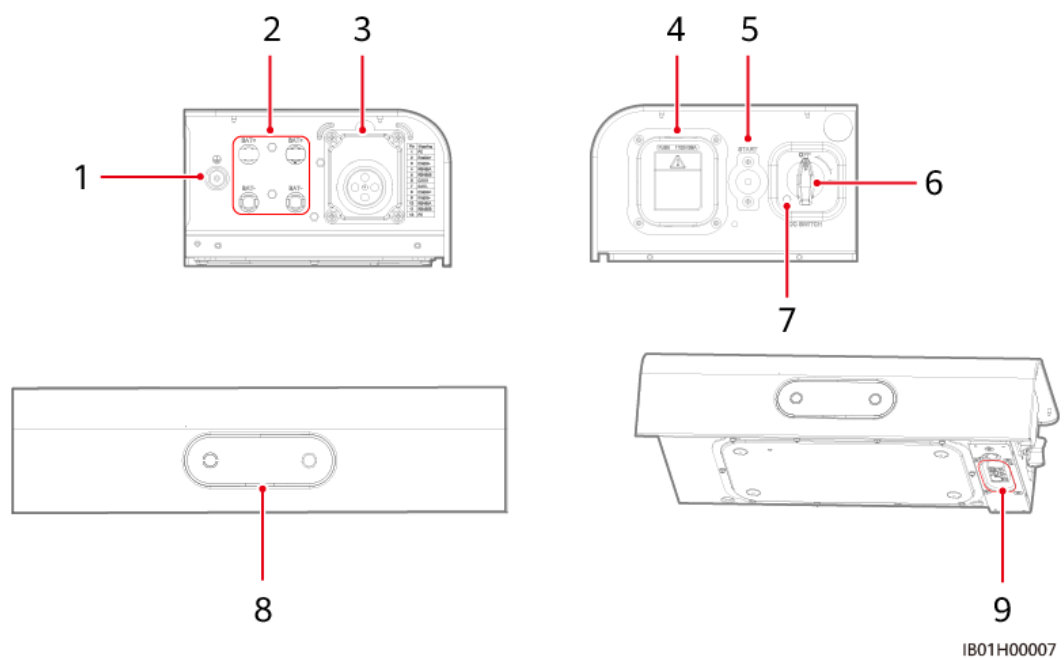

- | | | |
|--|--|----------------------------|
| (1) Ground point | (2) Energy storage terminals (BAT+/BAT-) | (3) COM port |
| (4) Fuse | (5) Black start button | (6) DC switch (DC SWITCH) |
| (7) DC switch locking screw hole (M4) ^a | (8) LED indicators | (9) Battery cascading port |

 **NOTE**

Note a: (Optional) Install the locking screw that secures the DC SWITCH to prevent misoperations.

Energy Storage Module

The standard capacity of an Energy Storage Module is 6.9 kWh.

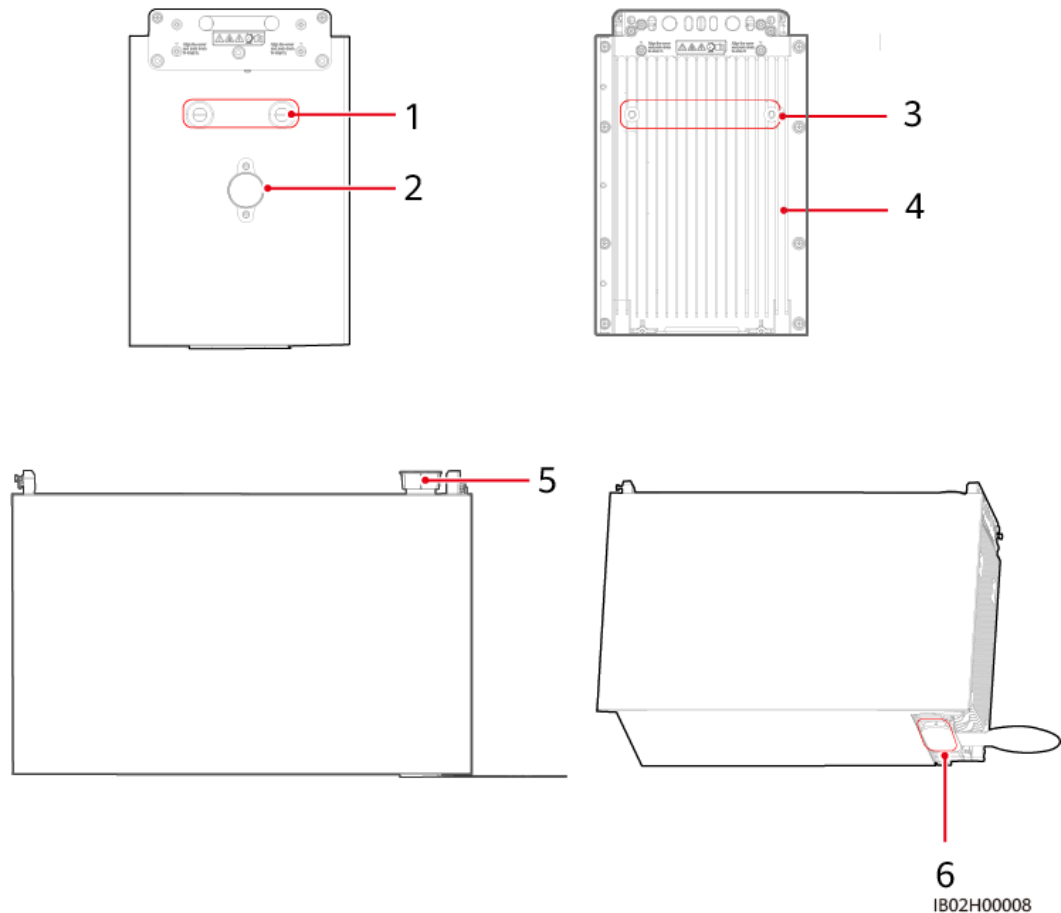

- | | | |
|--------------------------|------------------------------------|------------------------------------|
| (1) Lifting handle holes | (2) Explosion proof valve | (3) Lifting handle holes |
| (4) Heat sink | (5) Battery cascading port (upper) | (6) Battery cascading port (lower) |

2.3 Application Scenarios and Settings

2.3.1 Networking

 NOTE

 indicates AC power cables,  indicates DC power cables,
 indicates signal cables, and  indicates wireless communication.

 NOTE

- When used with the LUNA2000-(7, 14, 21)-S1, the SUN2000-(3KTL-10KTL)-M1 must be upgraded to SUN2000MA V100R001C00SPC157 or later.

Smart Dongle Networking

Figure 2-7 On-grid scenario

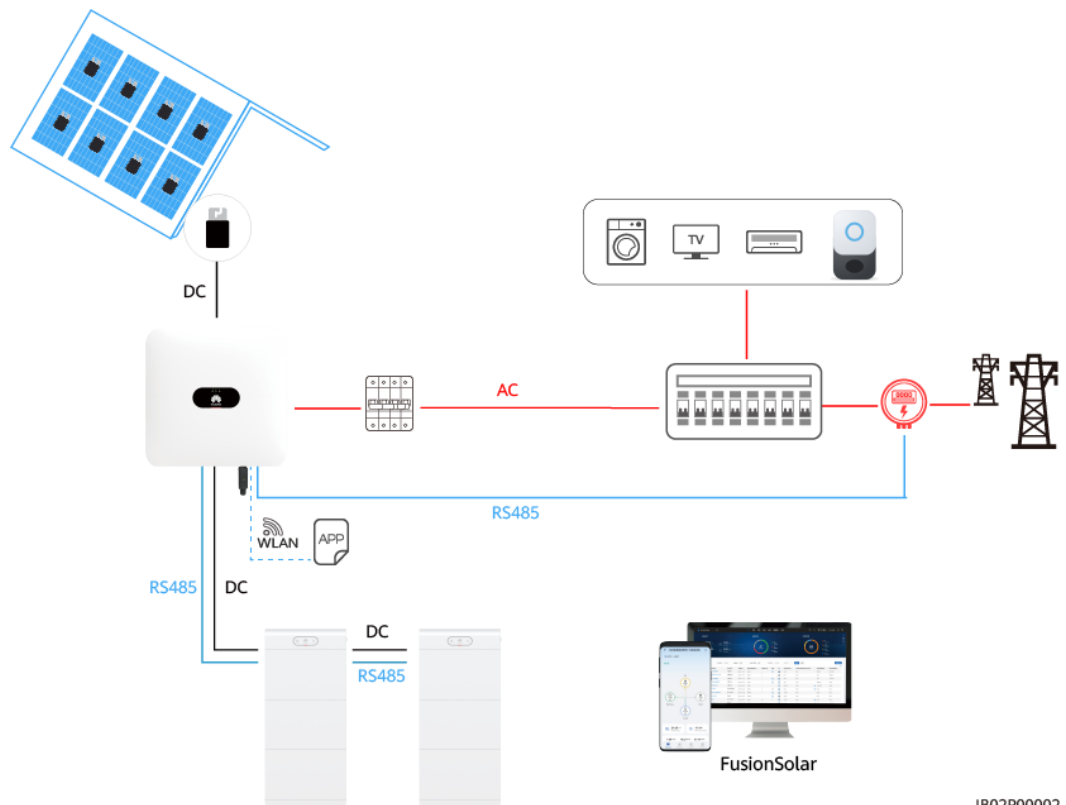

IB02P00002

Figure 2-8 On/Off-grid scenario

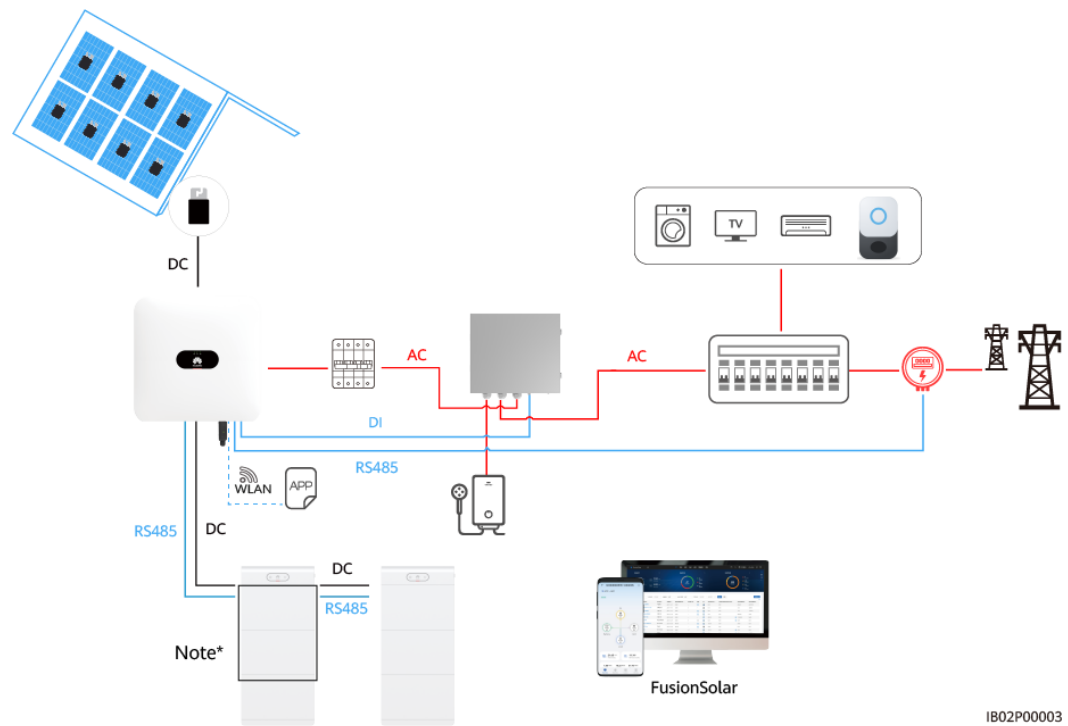

IB02P00003

NOTE

- Note*: When the SUN2000-(3KTL-10KTL)-M1 is used in the on/off-grid scenario, at least two Energy Storage Modules are required to ensure the stability of off-grid power supply to loads.

EMMA Networking

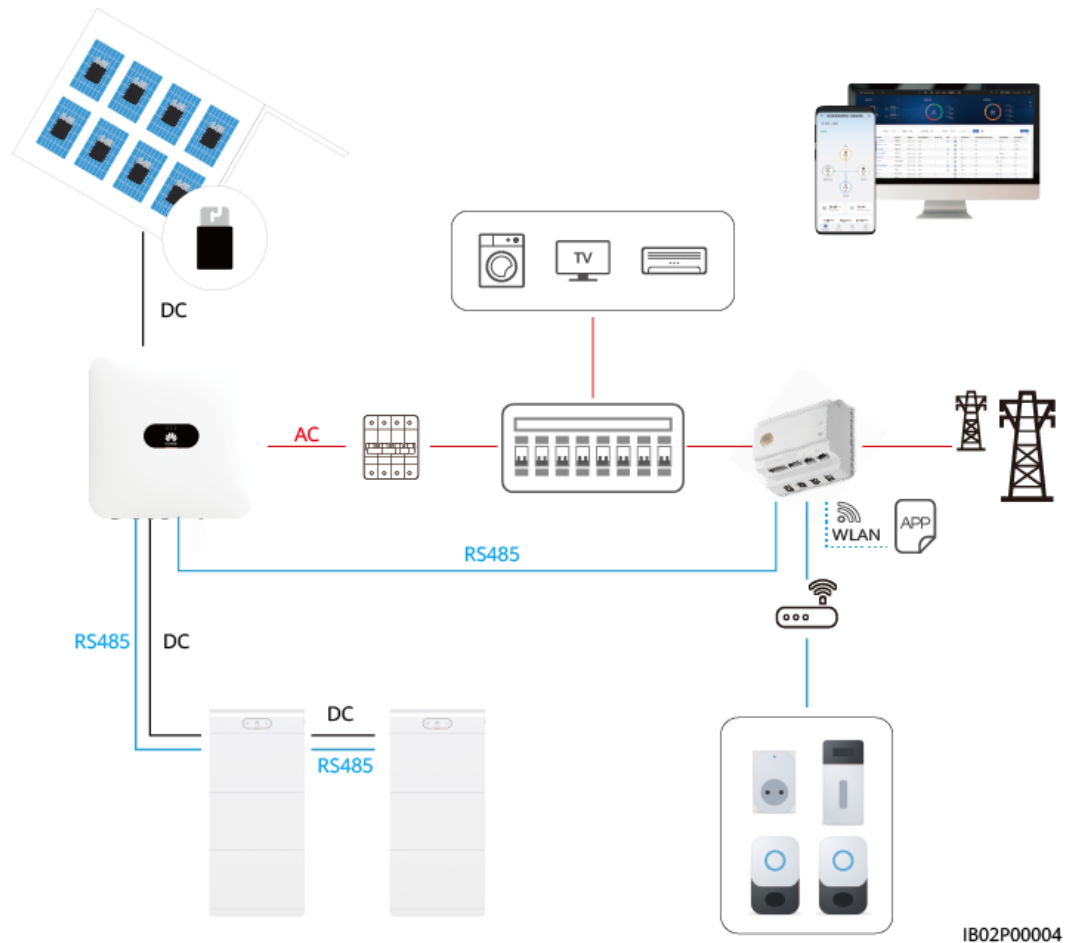

2.3.2 ESS Working Modes

The ESS supports three working modes: **Maximum self-consumption**, **TOU**, and **Fully fed to grid**.

Maximum Self-Consumption

- This mode applies to areas where the electricity price is high, or areas where the feed-in tariff (FIT) subsidy is low or unavailable.
- When the PV energy is sufficient for loads, the ESS stores the surplus PV energy. When the PV energy is insufficient or no PV energy is generated at night, the ESS discharges to supply power to loads. This improves the self-consumption rate of the PV system as well as energy self-sufficiency rate of the household, reducing electricity fees.
- Set the working mode to **Maximum self-consumption**. For details, see [6.4.2 Setting ESS Parameters](#).

Example:

System configuration: one 5KTL inverter, equipped with the 21 kWh ESS. The ESS works in the **Maximum self-consumption** mode.

- PV energy usage priority: Powering loads > Charging the ESS > Fed to grid

- Load power supply priority: PV power > ESS discharging > Grid

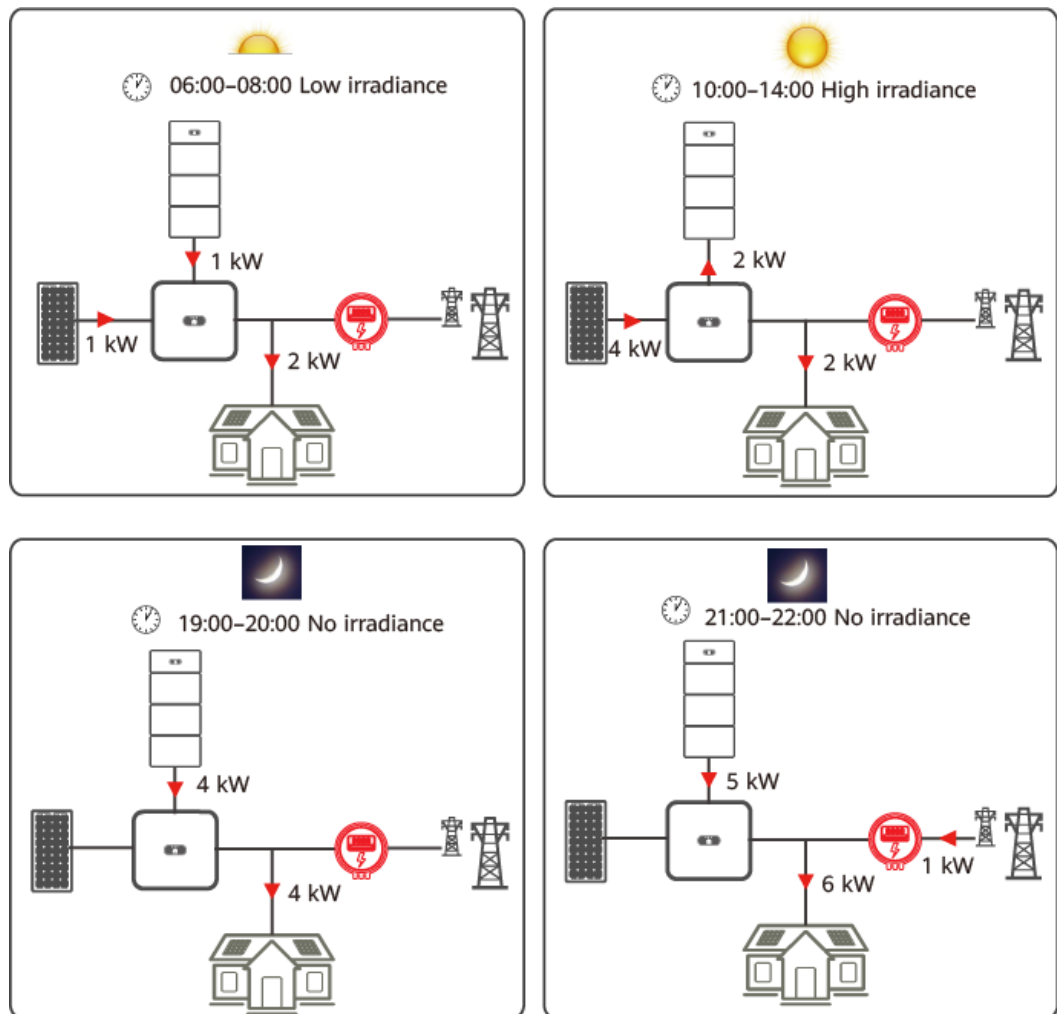

IB02P00005

TOU

- This mode applies to scenarios where the price difference is large between peak and off-peak hours. When the electricity price is low during off-peak hours, the grid supplies power to charge the ESS. When the electricity price is high during peak hours, the ESS discharges to supply power to household loads.
- In some countries, the grid is not allowed to charge the ESS. In such case, this mode cannot be used.
- In this mode, at least one charge time segment or one discharge time segment is required. During the charge time segment, the grid is allowed to charge the ESS. During the discharge time segment, the ESS can supply power to the loads. In other time segments that are not set, the ESS does not discharge, and the PV system and grid supply power to the loads. (In on/off-grid mode, if the grid fails, the ESS can discharge at any time.)
- Set the working mode to **TOU**. For details, see [6.4.2 Setting ESS Parameters](#).

Example:

00:00–06:00 is the low-price period, and 06:00–24:00 is the high-price period. Households usually use electricity in the high-price period.

System configuration: one 5KTL inverter, equipped with the 21 kWh ESS. Set the ESS working mode to **TOU**.

Set parameters as follows: Set **Grid charge cutoff SOC** to 50%. Set 00:00–06:00 as the charge time segment and 06:00–24:00 as the discharge time segment. Set **Priority of excess PV energy to Charge**.

- PV energy usage priority: Powering loads > Charging the ESS > Fed to grid
- Load power supply priority: PV power > ESS discharging > Grid

Figure 2-9 Example of TOU (00:00–06:00 charging and 6:00–24:00 discharging)

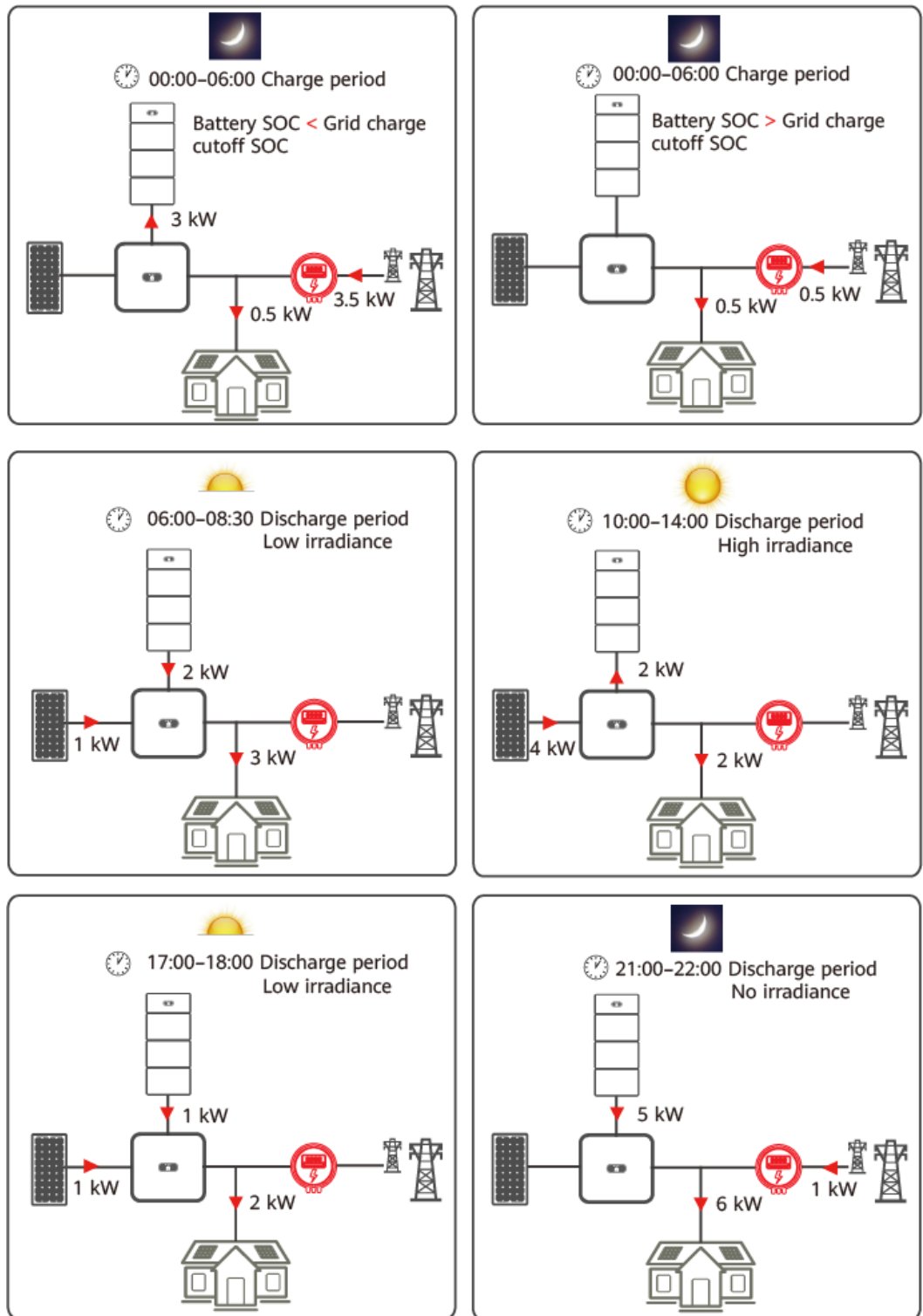

IB02P00006

Fully Fed to Grid

- This mode applies to on-grid scenarios where PV energy is fully fed to the grid.

- This mode maximizes the PV energy fed to the grid. When the generated PV energy in the daytime is greater than the maximum output capability of the inverter, the ESS is charged to store energy. When the PV energy is less than the maximum output capability of the inverter, the ESS discharges to maximize the energy fed from the inverter to the grid.
- Set the working mode to **Fully fed to grid**. For details, see [6.4.2 Setting ESS Parameters](#).

For example, when the PV system generates 8 kW of power, the 5KTL inverter feeds the maximum output power of 5.5 kW to the grid and charges the ESS at 2.5 kW. When the solar irradiance decreases, resulting in the PV system generating only 3 kW of power, the ESS discharges power at 2.5 kW to ensure that the inverter continues to feed the maximum output power of 5.5 kW to the grid.

Figure 2-10 Fully fed to grid

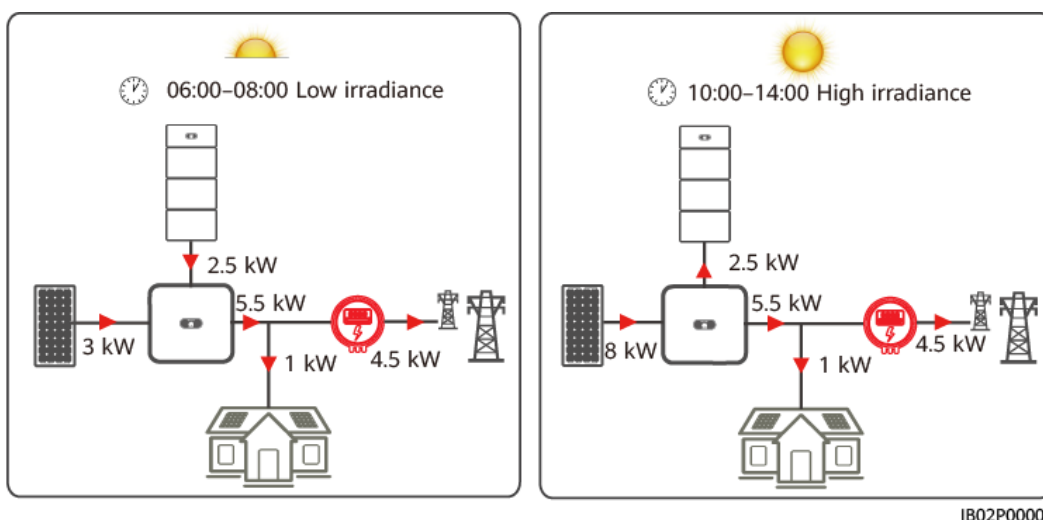







IB02P00007



2.4 Label Description

Enclosure Labels

Table 2-4 Enclosure label description

Label	Name	Meaning
	Delayed discharge	High voltage exists after the ESS is powered on. Residual voltage still exists after the ESS is powered off. It takes 5 minutes for the ESS to discharge to the safe voltage.

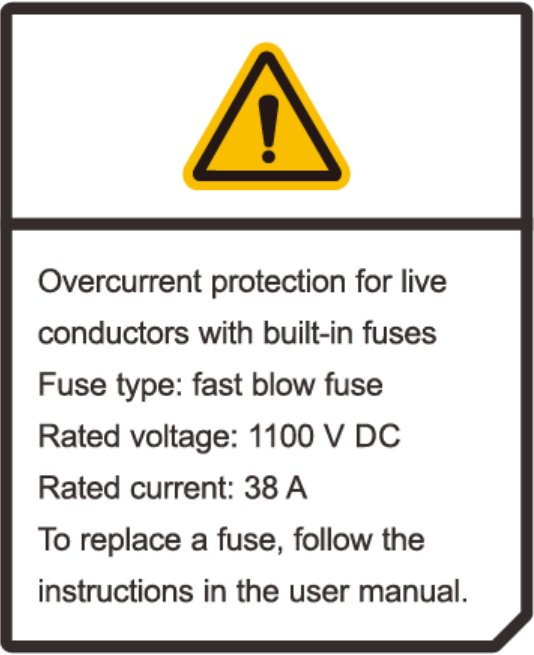
Label	Name	Meaning
	Burn warning	Do not touch the ESS, as the enclosure is hot when the ESS is running.
	Operation	<ul style="list-style-type: none"> • High voltage exists after the ESS is powered on. Only qualified and trained electrical technicians are allowed to install and operate the ESS. • Ground the ESS before powering it on.
	Refer to documentation	Reminds operators to refer to the documentation provided with the ESS.
	Usage prohibited when the ESS is dropped or experiences strong impact	Do not use an Energy Storage Module that is dropped or experiences strong impact. Otherwise, safety risks may occur, such as battery cell leakage and electric shock.
	Transportation	The weight of an Energy Storage Module is 68 kg. Use a forklift or assign multiple persons to move an Energy Storage Module. Be cautious to prevent injury when moving heavy objects.
	Base securing label	The base shall be secured to the ground using bolts. Otherwise, the equipment may fall down, causing personal injury or equipment damage.

Label	Name	Meaning
	<p>Fuse replacement</p>	<p>The fuse of the Energy Storage Control Unit can be replaced. For details, see the ESS replacement section in the manual.</p>
	<p>Warning signs such as those for the installation environment</p>	<ul style="list-style-type: none"> • Keep the ESS away from fire and heat sources and out of reach of children to avoid high voltage hazards. • Store and charge the ESS in strict accordance with the manual to prevent damage caused by storing the ESS in a low state-of-charge (SOC) for extended periods of time. • It is recommended that the ESS be installed outdoors under an awning. When installing the ESS in a garage, keep it clear of the driving path. You are advised to install the ESS higher than the vehicle bumper.

 NOTE

The labels are for reference only.

Nameplate

Figure 2-11 Nameplate of the Energy Storage Control Unit

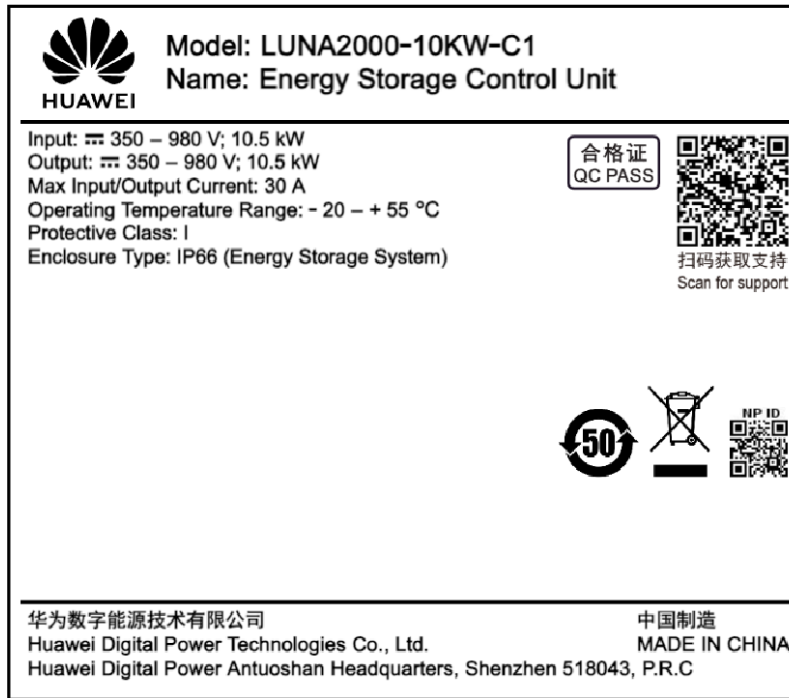
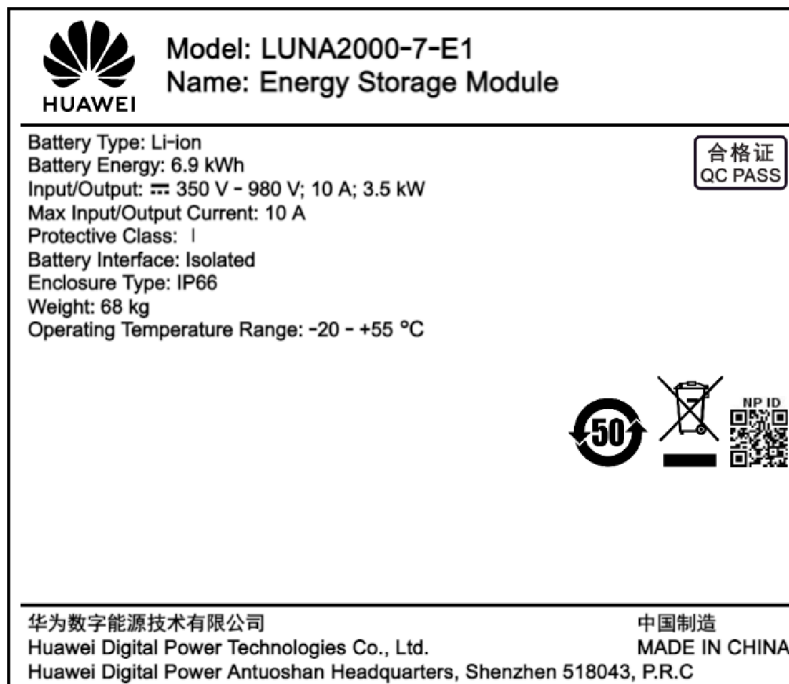

Figure 2-12 Nameplate of the Energy Storage Module



2.5 Working Modes

The LUNA2000 converts high-voltage DC power generated by PV strings to low-voltage DC power and stores the low-voltage DC power in the Energy Storage Module. The LUNA2000 also converts low-voltage DC power from the Energy Storage Module to high-voltage DC power which is then converted to AC power through the inverter.

The LUNA2000 works in hibernation, standby, or operating mode.

Table 2-5 Working modes

Working Mode	Description
Hibernation mode	The ESS's internal auxiliary power source and the power unit do not work.
Standby mode	The ESS's internal auxiliary power source works, but the power unit does not work.
Operating mode	The ESS's internal auxiliary power source works, and the power unit charges or discharges.

Figure 2-13 Working mode switching

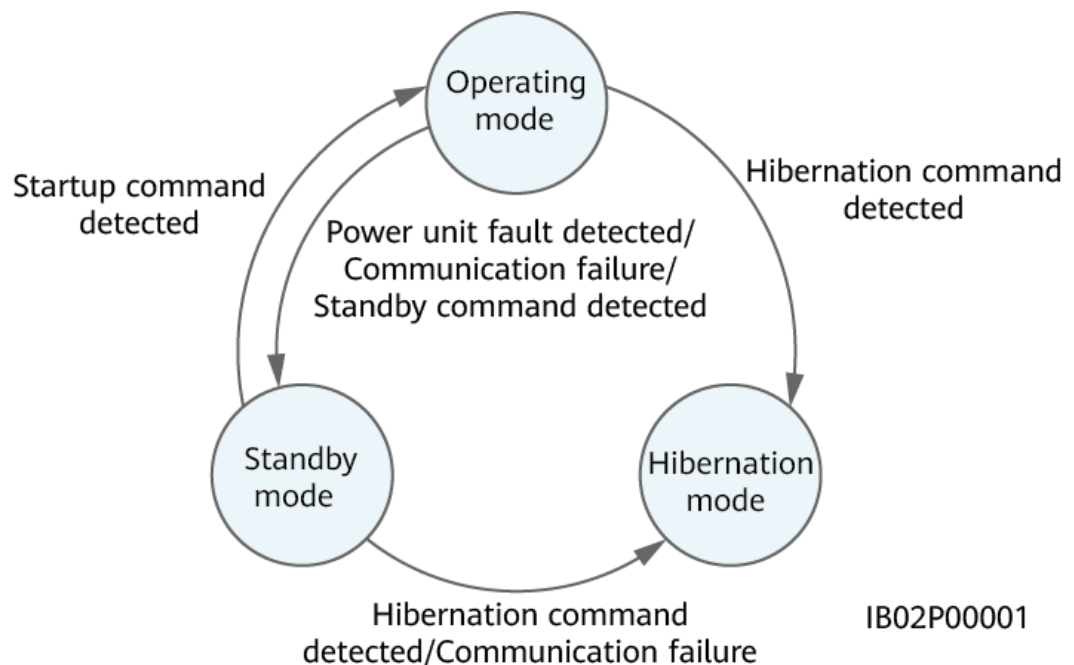

3 Transportation and Storage

3.1 Transportation Requirements

- Be cautious to prevent injury when moving heavy objects.



< 18 kg
(< 40 lbs)



18–32 kg
(40–70 lbs)



32–55 kg
(70–121 lbs)

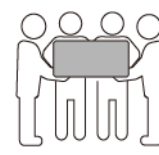

55–68 kg
(121–150 lbs)



> 68 kg
(> 150 lbs)

CZ0000110

- If multiple persons need to move a heavy object together, determine the manpower and work division with consideration of height and other conditions to ensure that the weight is equally distributed.
- If two persons or more move a heavy object together, ensure that the object is lifted and landed simultaneously and moved at a uniform pace under the supervision of one person.
- Wear personal protective gears such as protective gloves and shoes when manually moving the equipment.
- To move an object by hand, approach to the object, squat down, and then lift the object gently and stably by the force of the legs instead of your back. Do not lift it suddenly or turn your body around.
- Do not quickly lift a heavy object above your waist. Place the object on a workbench that is half-waist high or any other appropriate place, adjust the positions of your palms, and then lift it.
- Move a heavy object stably with balanced force at an even and low speed. Put down the object stably and slowly to prevent any collision or drop from scratching the surface of the equipment or damaging the components and cables.
- When moving a heavy object, be aware of the workbench, slope, staircase, and slippery places. When moving a heavy object through a door, ensure that the door is wide enough to move the object and avoid bumping or injury.

- When transferring a heavy object, move your feet instead of turning your waist around. When lifting and transferring a heavy object, ensure that your feet point to the target direction of movement.
- When transporting the equipment using a pallet truck or forklift, ensure that the tynes are properly positioned so that the equipment does not topple. Before moving the equipment, secure it to the pallet truck or forklift using ropes. When moving the equipment, assign dedicated personnel to take care of it.
- Choose sea or roads in good conditions for transportation. Do not transport the equipment by railway or air. Avoid tilt or jolt during transportation.

 **DANGER**

Load or unload batteries with caution. Otherwise, the batteries may be short-circuited or damaged (such as leakage and crack), catch fire, or explode.

 **WARNING**

Do not move a battery by holding its terminals, bolts, or cables. Otherwise, the battery may be damaged.

Keep batteries in the correct direction during transportation. They must not be placed upside down or tilted, and must be protected against falling down, mechanical impact, rains, snows, and falling into water during transportation.

 **WARNING**

Before unpacking, storage, and transportation, ensure that the packing cases are intact and the batteries are correctly placed according to the labels on the packing cases. Do not place a battery upside down or vertically, lay it on one side, or tilt it. Stack the batteries according to the stacking requirements on the packing cases. Ensure that the batteries do not fall or get damaged. Otherwise, they will need to be scrapped.

- According to the UN *Recommendations on the Transport of Dangerous Goods: Model Regulations* (also referred to as TDG or UN Orange Book), batteries belong to class 9 dangerous goods and shall pass the related tests required in Part III Subsection 38.3 of the UN *Recommendations on the Transport of Dangerous Goods: Manual of Tests and Criteria*.
- Comply with the latest international and national rules on the transportation and storage of dangerous goods, including but not limited to the *International Maritime Dangerous Goods Code* (IMDG Code), *Agreement concerning the International Carriage of Dangerous Goods by Road* (ADR), and China's transportation industry standards (JT/T 617) *Regulations concerning road transportation of dangerous goods*, as well as the requirements of the transportation regulatory authorities in the countries of departure, route, and destination. Before transportation and storage, properly pack, label, and mark products according to the local laws, regulations, and standards, and complete related product and packaging tests.

- Transportation and storage service providers must have the qualifications for dangerous goods operations required by local laws, regulations, and standards. Rigid box trucks shall be used for transportation and pickup trucks are prohibited.
- Choose sea or roads in good conditions for transportation. Do not transport the equipment by railway or air. Avoid tilt or jolt during transportation.
- Before transportation, ensure that the battery packaging, labels, and markings are intact and there is no abnormal smell, leakage, smoke, or fire. Otherwise, the batteries must not be transported.
- The packing case must be solid and strong. Handle the packages with care and take moisture-proof measures during loading, transportation, and unloading. Do not place the packages on one side or upside down. Bind the packages securely to avoid displacement. Ensure that the dangerous goods labels are visible.
- Exercise caution when moving batteries to prevent bumping and ensure personal safety.
- Unless otherwise specified, dangerous goods must not be mixed with goods containing food, medicine, animal feed, or their additives in the same vehicle or container.
- If the local laws, regulations, and standards allow the mixed transportation of specified different dangerous goods and that of dangerous goods and common goods, the dangerous goods shall be isolated according to the local laws, regulations, and standards. If there is no specific local requirement, refer to the following requirements for isolation when dangerous goods and common goods are in the same vehicle or container:
 - Use a spacer that is as high as the packages.
 - Keep a distance of at least 0.8 m around.
- Store batteries in a separate area away from heat sources. Protect batteries from moisture, water, and rain. Stack batteries according to the labels on the packing case. Do not stack batteries more than the allowed stacking layers. Do not place batteries on one side or upside down.
- Before transporting a faulty battery (with scorch, leakage, bulge, or water intrusion), insulate its positive and negative terminals, pack it, and place it in an insulated explosion-proof box as soon as possible. Record information such as the site name, address, time, and fault symptom on the box.
- When transporting faulty batteries, avoid approaching flammable material storage areas, residential areas, or other densely populated places, such as mass transit facilities or elevators.

3.2 Storage Requirements

WARNING

- Ensure that batteries are stored in a dry, clean, and ventilated indoor environment that is free from sources of strong infrared or other radiations, organic solvents, corrosive gases, and conductive metal dust. Do not expose batteries to direct sunlight or rain and keep them far away from sources of heat and ignition.
 - If a battery is faulty (with scorch, leakage, bulge, or water intrusion), move it to a dangerous goods warehouse for separate storage. The distance between the battery and any combustible materials must be at least 3 m. The battery must be scrapped as soon as possible.
 - Place batteries correctly according to the signs on the packing case during storage. Do not place batteries upside down, lay them on one side, or tilt them. Stack batteries in accordance with the stacking requirements on the packing cases.
 - Store batteries in a separate place. Do not store batteries together with other devices. Do not stack batteries too high. If a large number of batteries are stored onsite, it is recommended that the site be equipped with qualified fire fighting facilities, such as fire sand and fire extinguishers.
-

CAUTION

It is recommended that batteries be used soon after being deployed onsite. Batteries that have been stored for an extended period shall be charged periodically. Otherwise, they may be damaged.

- The storage environment must comply with local regulations and standards.
- The storage environment must be clean and dry. The product must be protected against rain and water.
- The air must not contain corrosive or flammable gases.
- The storage environment requirements are as follows:
 - Ambient temperature: -10–55°C; recommended storage temperature: 20–30°C
 - Relative humidity: 5% to 80%
- If a battery has been stored for longer than the allowed period, it must be checked and tested by professionals before use.
- Proof that the product is stored according to the requirements must be available, such as temperature and humidity log data, storage environment photos, and inspection reports.
- Ensure that batteries are delivered based on the "first in, first out" rule.
- Ensure that the storage duration starts from the latest charge time marked on the battery packing case and that the latest charge time is updated after every charge.

3.3 Battery Charge

Battery Acceptance Inspection

There must be a battery charge label on the packing case. The charge label must specify the latest charge time and the next charge time.

Battery Charge Requirements

1. AC mains input voltage requirements on the charging facilities: single-phase voltage: 220 V/230 V/240 V, $\pm 10\%$; three-phase voltage: 380 V/400 V, $\pm 10\%$.
2. The warehouse keeper shall collect battery storage information every month and periodically report the battery inventory information to the planning department to ensure that batteries are charged in a timely manner.
3. After the battery production test is complete and before the batteries are stored, the batteries must be charged to at least 50% SOC.

Conditions for Determining Long-term Storage

Do not store batteries for extended periods of time. The deep discharge during storage may damage batteries. If you have to store batteries, observe the following storage requirements.

Table 3-1 Lithium battery charge intervals

Required Storage Temperature	Actual Storage Temperature	Charge Interval	Remarks
$-10^{\circ}\text{C} < T \leq +55^{\circ}\text{C}$	$T \leq -10^{\circ}\text{C}$	Not allowed	Not reaching the time for charge: Use the batteries as soon as possible.
	$-10^{\circ}\text{C} < T \leq +25^{\circ}\text{C}$	15 months	
	$25^{\circ}\text{C} < T \leq 35^{\circ}\text{C}$	9 months	
	$35^{\circ}\text{C} < T \leq 55^{\circ}\text{C}$	6 months	Reaching the time for charge: Charge the batteries.
	$T > 55^{\circ}\text{C}$	Not allowed	

1. Dispose of deformed, damaged, or leaking batteries directly irrespective of how long they have been stored.
2. The storage duration starts from the latest charge time labeled on the battery package. If a battery is qualified after charge, update the latest charge time and the next charge time (Next charge time = Latest charge time + Charge interval) on the label.
3. Batteries can be charged for a maximum of three times during storage. Dispose of batteries if the maximum charge times are exceeded.
4. Long-term storage of lithium batteries will cause capacity loss. The longer the storage duration, the greater the capacity loss. Batteries may fail the

discharge acceptance tests when their capacity after storage is less than 100% of the rated capacity.

Inspection Before Charge

1. Before charging a battery, you need to check its appearance. Charge the qualified battery or dispose of the unqualified one.
2. The battery is qualified if it is free from the following symptoms:
 - Deformation
 - Shell damage
 - Leakage

Battery Charging Cable Connection

Connect cables by referring to [5 Electrical Connections](#).

Figure 3-1 Cable connection diagram

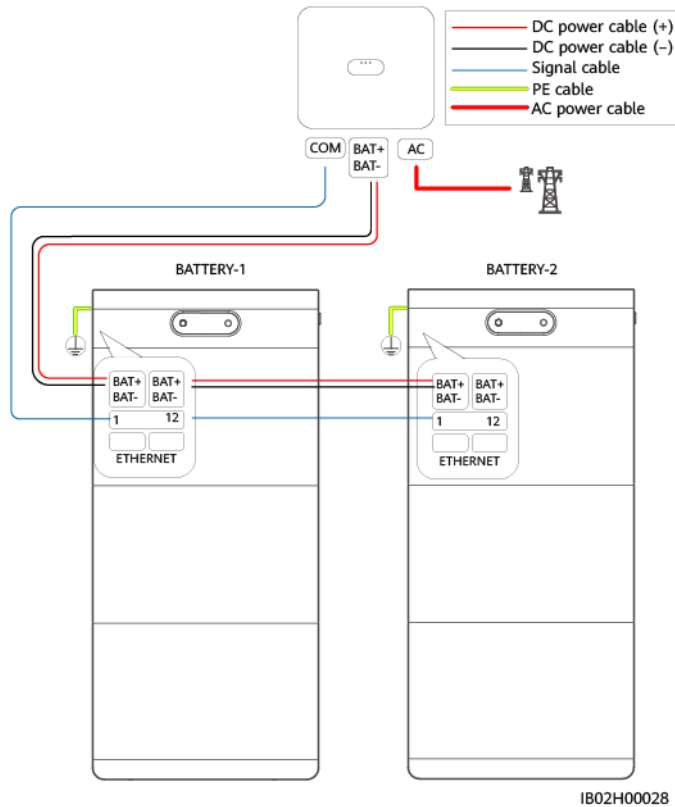

Charge Procedure

NOTICE

- Ensure that the charge process is supervised to prevent any abnormality.
- If a battery experiences an abnormality such as bulging or smoking, stop charging immediately and dispose of it.
- Ensure that only trained professionals perform charge operations.
- If the battery SOC is 0%, the battery cannot be activated by holding down the black start button. The battery can be started only after both the DC and AC power supplies to the inverter are connected.
- It is recommended that a battery be charged to 50% SOC. If a lithium battery is stored for extended periods of time, capacity loss may occur. After a lithium battery is stored for 12 months at the recommended storage temperature, the irreversible capacity loss rate is 3%–10%.

Step 1 Connect cables correctly.

Step 2 Set the DC SWITCH to ON.

Step 3 Turn on the AC switch between the inverter and the power grid.

Step 4 Observe the LED indicators on the inverter and check that the AC indicator  is blinking green slowly.

Step 5 Hold down the black start button for 8s to activate the ESS.

Step 6 **Connect the inverter on the app.** Tap **Monitor** on the home screen, tap the ESS icon, and check that all Energy Storage Modules are online.

Step 7 Choose **Maintenance > Battery maintenance > Forced charge/discharge**, set **Working Mode** to **Maintenance charge**, and enable **Maintenance charge**.

Step 8 Check that the circular SOC indicator stops blinking or the status displayed on the app is **Charging completed**.

Step 9 After the charging is complete, turn off the AC switch between the inverter and the power grid, and then set the DC SWITCH to OFF. If other ESSs need to be charged, repeat the preceding steps.

----End

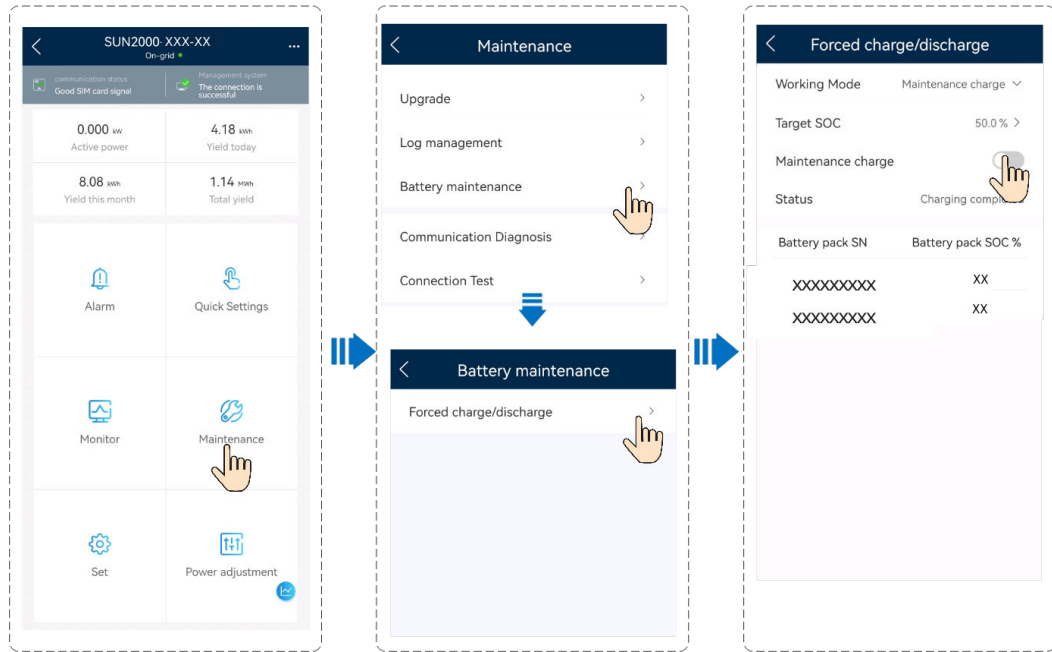

4 Installing the ESS

 **DANGER**

Note the polarities when installing batteries. Do not connect the positive and negative poles of a battery or battery string together. Otherwise, the battery may be short-circuited.

 **WARNING**

- Tighten the screws on copper bars or cables to the torque specified in this document. Periodically confirm whether the screws are tightened, check for rust, corrosion, or other foreign objects, and clean them up if any. Loose screw connections will result in excessive voltage drops and batteries may catch fire when the current is high.
 - When installing batteries, do not place installation tools, metal parts, or sundries on the batteries. After the installation is complete, clean up the objects on the batteries and the surrounding area.
-

 **WARNING**

Before unpacking, storage, and transportation, ensure that the packing cases are intact and the batteries are correctly placed according to the labels on the packing cases. Do not place a battery upside down or vertically, lay it on one side, or tilt it. Stack the batteries according to the stacking requirements on the packing cases. Ensure that the batteries do not fall or get damaged. Otherwise, they will need to be scrapped.

 **WARNING**

After unpacking batteries, place them in the required direction. Do not place a battery upside down or vertically, lay it on one side, tilt it, or stack it. Ensure that the batteries do not fall or get damaged. Otherwise, they will need to be scrapped.

 CAUTION

- Slowly push or move battery packs to prevent damage and collision.
 - To prevent battery packs from falling off, start the pallet truck or forklift after confirming that battery packs are securely bound.
 - When moving batteries, do not remove protective components such as protective covers or waterproof caps from battery terminals.
 - Exercise caution when moving batteries to prevent bumping and ensure personal safety.
 - Install and secure batteries horizontally from the bottom up and from left to right to prevent falling over due to imbalance.
 - When connecting batteries, ensure that the spring washer on the screw is leveled, that the protruding part of the terminal on the cable faces outwards, and that the cable is intact.
-

 CAUTION

- Install and secure batteries horizontally from the bottom up and from left to right to prevent falling over due to imbalance.
 - Ensure that the power circuit breaker is OFF before installing batteries.
 - Keep the battery loop disconnected during installation and maintenance.
-

NOTICE

- Do not use a damaged battery (such as damage caused when a battery is dropped, bumped, bulged, or dented on the enclosure), because the damage may cause electrolyte leakage or flammable gas release. In the case of electrolyte leakage or structural deformation, contact the installer or professional O&M personnel immediately to remove or replace the battery. Do not store the damaged battery near other devices or flammable materials and keep it away from non-professionals.
 - Before installing a battery pack, check that its enclosure is not deformed or damaged.
-

4.1 Pre-installation Check

Checking Outer Packaging

Before unpacking the ESS, check the outer packaging for damage, such as holes and cracks, and check the ESS model. If any damage is found or the model is not what you requested, do not unpack the ESS and contact your vendor as soon as possible.









Checking Deliverables

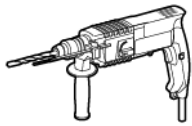
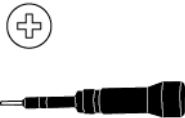



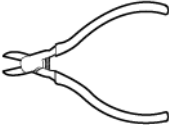
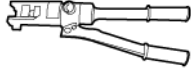
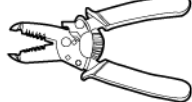



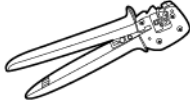
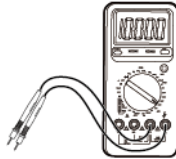

After unpacking the ESS, check that the deliverables are intact and complete, and free from any obvious damage. If any item is missing or damaged, contact your vendor.

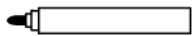
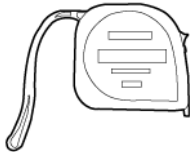
 **NOTE**

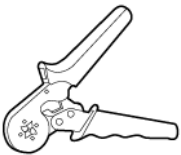
For details about the number of deliverables, see the *Packing List* in the packing case.

4.2 Tools

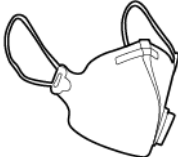
Category	Tool			
Installation tool	 Hammer drill Drill bit: $\Phi 8$ mm, $\Phi 12$ mm, and $\Phi 16$ mm	 Phillips insulated torque screwdriver	 Hex insulated torque screwdriver	 Insulated torque socket wrench
	 Hex key	 Diagonal pliers	 Hydraulic pliers	 Wire stripper
	 Cable tie	 Spanner Model: PV-MS-HZ open-end wrench Manufacturer: Staubli	 Rubber mallet	 Utility knife

Category	Tool			
	 Cable cutter	 Crimping tool Model: PV-CZM-22100/19100 Manufacturer: Staubli	 Multimeter DC voltage measurement range ≥ 1100 V DC	 Vacuum cleaner
	 Marker	 Steel measuring tape	 Level	 Cord end terminal crimping tool
	 Heat shrink tubing	 Heat gun	-	-
Personal protective equipment (PPE)	 Insulated gloves	 Protective gloves	 Dust mask	 Protective shoes
	 Goggles	-	-	-

4.3 Moving an Energy Storage Module

WARNING

- Be cautious to prevent injury when moving heavy objects. (The weight of an Energy Storage Module is 68 kg.)
- Use lifting handles to move an Energy Storage Module. Do not move it directly with your hands.
- Ensure that the lifting handles are securely connected to the Energy Storage Module, with the steel washers of the lifting handles closely fitted to the Energy Storage Module. Do not lift the Energy Storage Module before the lifting handles are tightened.
- The lifting handles are auxiliary moving tools and not applicable to long-distance transportation.
- Do not use a damaged lifting handle. If the stud of a lifting handle is bent, replace the lifting handle promptly.

Figure 4-1 Using lifting handles

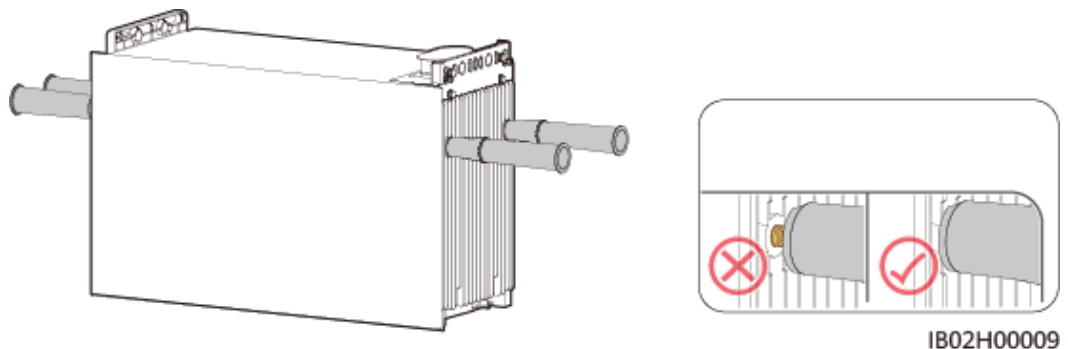

4.4 Installation Requirements

Installation Angle Requirements

The ESS can be installed on a floor or wall. The installation angle requirement is as follows:

- Do not install the ESS at forward tilted, back tilted, side tilted, horizontal, or upside down positions.

Figure 4-2 Installation angle

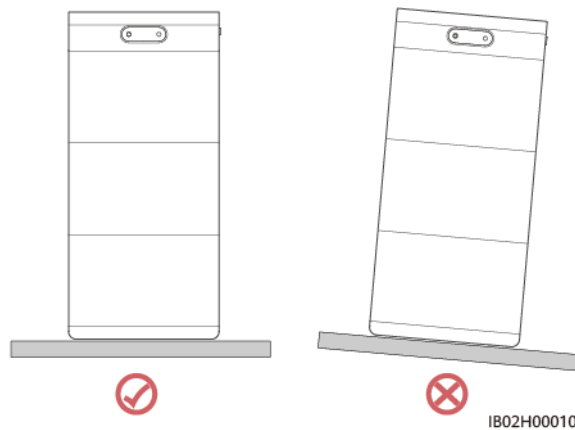

Installation Position Requirements

Install the ESS on a solid brick-concrete structure or concrete wall or floor. If other types of walls and floors are used, they must be made of fire-retardant materials and meet the load-bearing requirements of the equipment. (The weight of an Energy Storage Module is 68 kg.)

Installation Clearance Requirements

- During installation, ensure that there is no other equipment (except related Huawei equipment and awnings) or flammable or explosive materials around the ESS. Reserve sufficient clearances for heat dissipation and safety isolation.
- When mounting the ESS on a wall, do not place any objects under the ESS.

Figure 4-3 ESS installation requirements

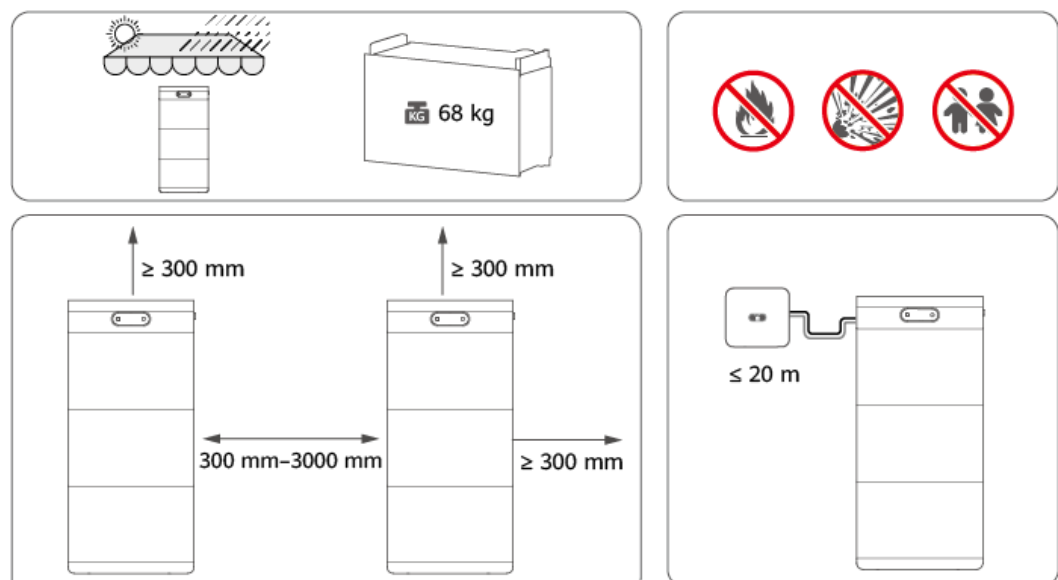

4.5 Installing the ESS

4.5.1 Floor Mounting

Floor-mounting Holes

Figure 4-4 shows the dimensions of floor-mounting holes for the ESS.

Figure 4-4 Dimensions for floor mounting

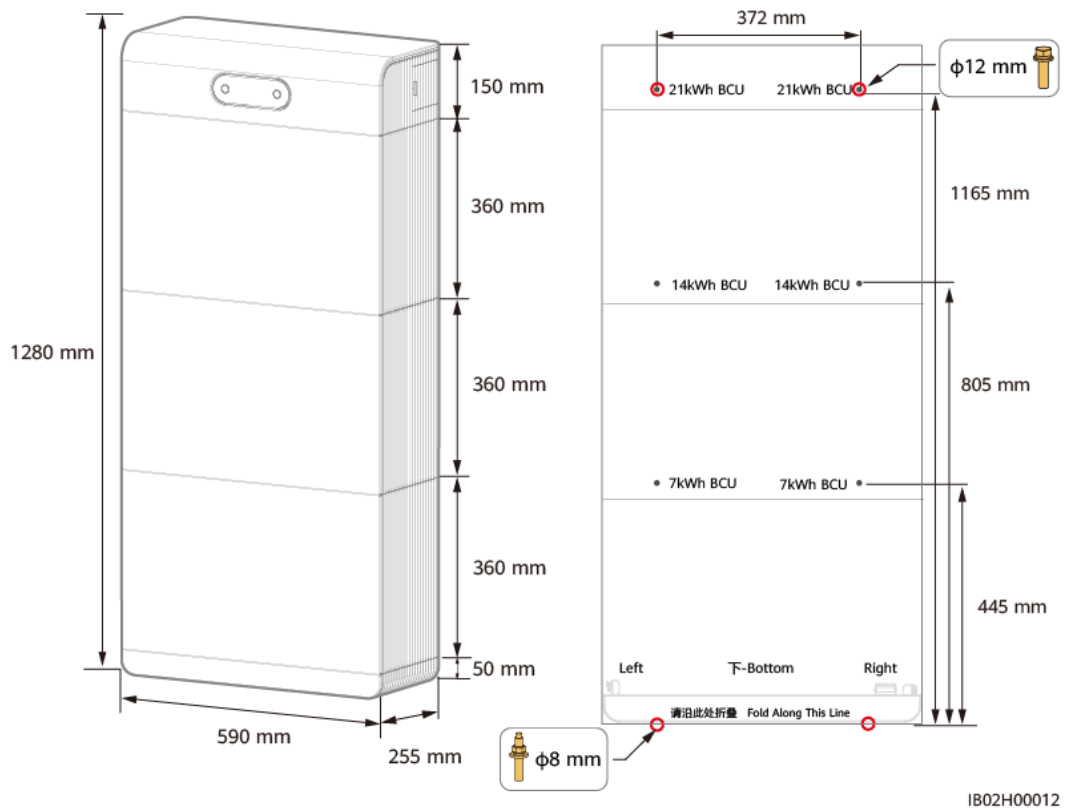

Procedure

⚠ DANGER

- Avoid drilling holes into the water pipes or power cables buried in the wall.
-

⚠ CAUTION

When installing the equipment, ensure that the installation surface is flat and solid enough to bear the weight of the equipment. Do not over-adjust the horizontal adjustment nut of the floor-mounting bracket. Ensure that the horizontal adjustment nut is screwed into more than 1/2 of the thread depth. If the thread depth is too small, the screw thread may be damaged due to excessive force because the Energy Storage Module is heavy.

NOTICE

- To prevent dust inhalation or contact with eyes, wear safety goggles and a dust mask when drilling holes.
- Use a vacuum cleaner to clean up dust in and around the holes, and measure the spacing. If the holes are inaccurately positioned, drill the holes again.

NOTE

Expansion bolts are delivered with the product. If the length or number of the bolts do not meet installation requirements, prepare stainless steel expansion bolts by yourself. The expansion bolts delivered with the product are used for solid brick-concrete walls and concrete floors. If other types of walls and floors are used, ensure that the load-bearing capacity requirements (the weight of one Energy Storage Module is 68 kg) are met and appropriate bolts are selected.

NOTICE

- Before installing an Energy Storage Module, clean the ports on the base. Ensure that the ports are dry and free from dust and foreign objects. Otherwise, the equipment may be damaged.
- Before tightening the screws on both sides of the equipment, ensure that the front panels of the modules are flush with each other.

-
- Step 1** Fold the marking-off template as required and place it 15–20 mm away from the wall. Mark the mounting holes on the floor. Then, attach the marking-off template to the wall, mark the mounting holes on the wall, and use a hammer drill to drill holes.
 - Step 2** Loosen the screws on both sides, separate the floor-mounting bracket from the Energy Storage Control Unit, and remove the floor-mounting bracket.
 - Step 3** Rotate the leveling adjustment nut, use a level instrument to level the bracket, and secure the bracket using expansion bolts.
 - Step 4** Install the first Energy Storage Module, move the Energy Storage Module onto the floor-mounting bracket using lifting handles, tighten the screws on both sides, and remove the protective cover from the battery cascading port on the top.
 - Step 5** Install the second Energy Storage Module and tighten the screws on both sides.
 - Step 6** Install the third Energy Storage Module, tighten the screws on both sides, and install the L-shaped mounting brackets.
 - Step 7** Install the Energy Storage Control Unit and tighten the screws on both sides.

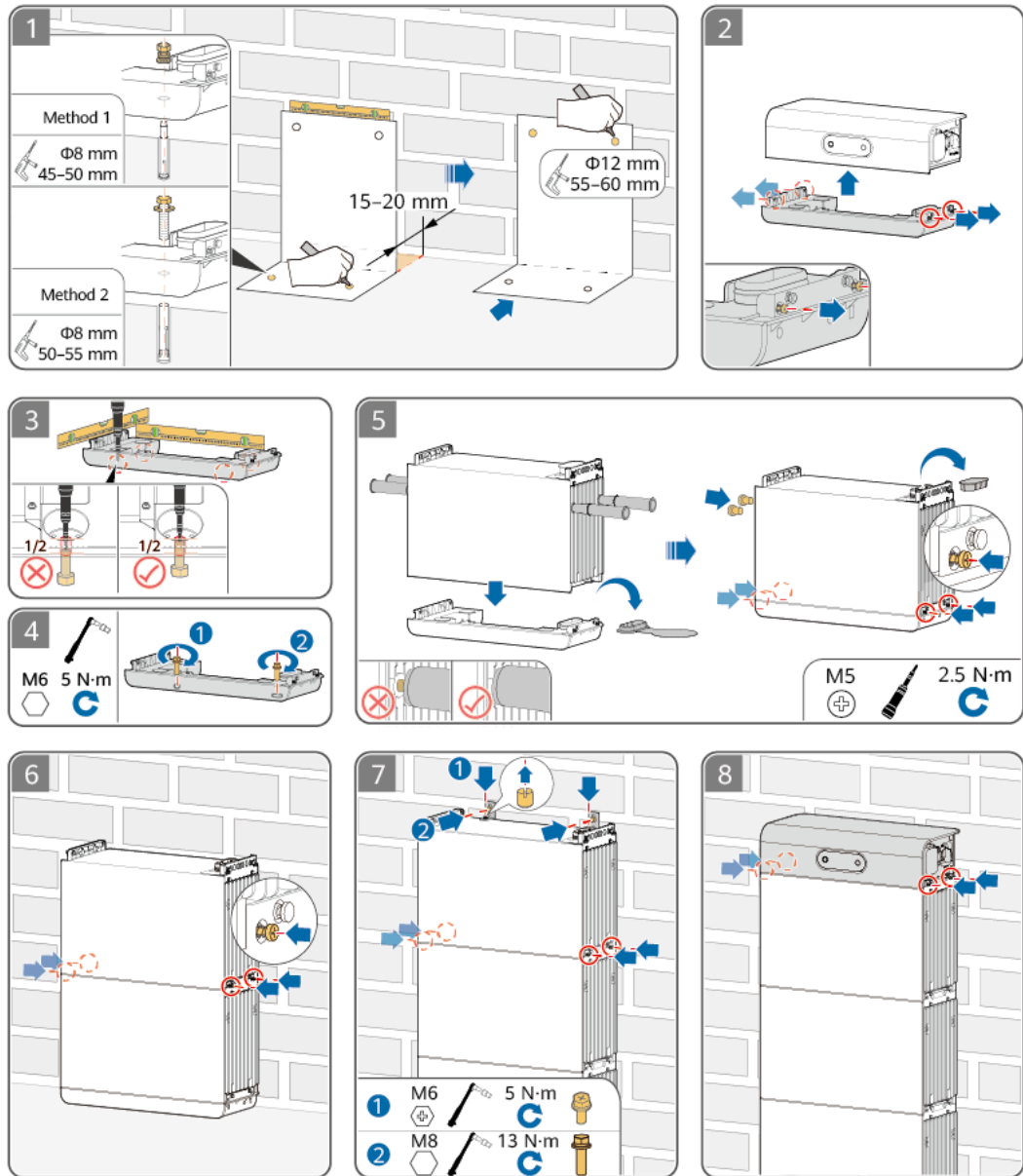

----End

4.5.2 Wall Mounting

Wall-mounting Holes

Figure 4-5 shows the dimensions of wall mounting holes for the ESS.

Figure 4-5 Dimensions for wall mounting

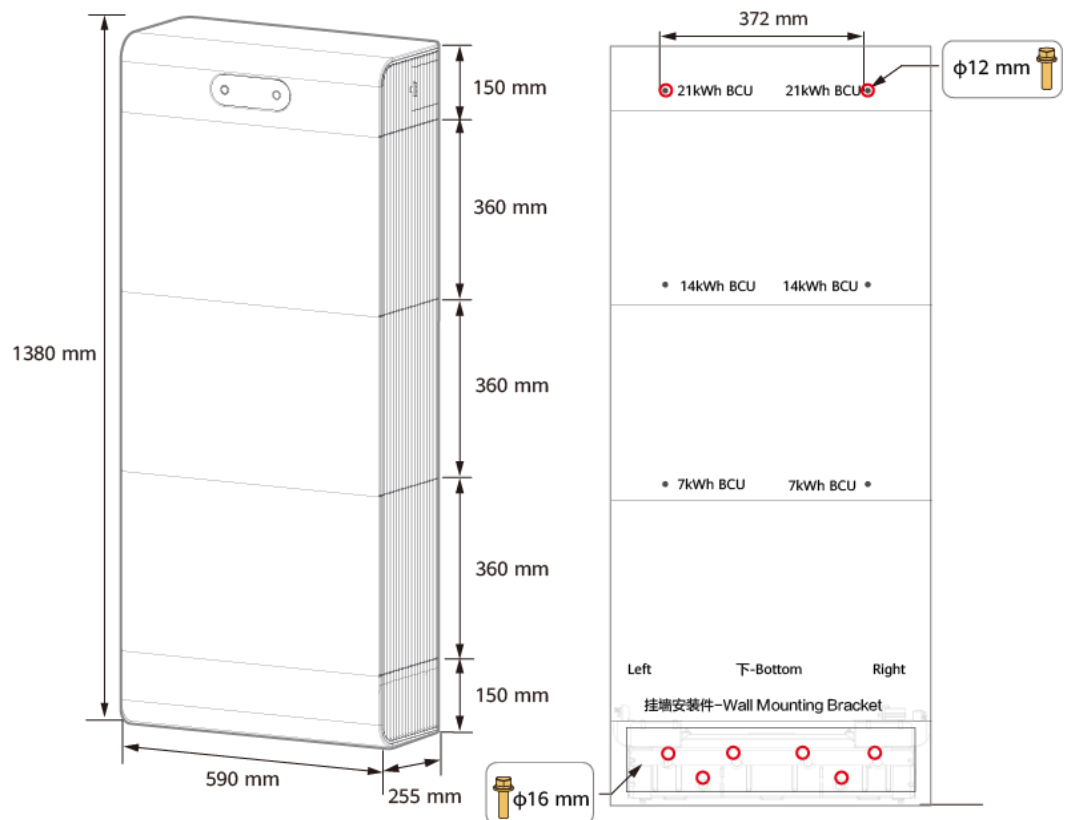

IB02H00025

Procedure

DANGER

- Avoid drilling holes into the water pipes or power cables buried in the wall.

NOTICE

- To prevent dust inhalation or contact with eyes, wear safety goggles and a dust mask when drilling holes.
- Use a vacuum cleaner to clean up dust in and around the holes, and measure the spacing. If the holes are inaccurately positioned, drill the holes again.

NOTE

Expansion bolts are delivered with the product. If the length or number of the bolts do not meet installation requirements, prepare stainless steel expansion bolts by yourself. The expansion bolts delivered with the product are used for solid brick-concrete walls and concrete floors. If other types of walls and floors are used, ensure that the load-bearing capacity requirements (the weight of one Energy Storage Module is 68 kg) are met and appropriate bolts are selected.

NOTICE

- Before installing an Energy Storage Module, clean the ports on the base. Ensure that the ports are dry and free from dust and foreign objects. Otherwise, the equipment may be damaged.
 - Before tightening the screws on both sides of the equipment, ensure that the front panels of the modules are flush with each other.
-

Step 1 Assemble the wall-mounting bracket.

Step 2 Mark the positions for drilling holes using the marking-off template and drill holes using a hammer drill.

Step 3 Install the wall-mounting bracket.

Step 4 Install the panel of the wall-mounting bracket.

Step 5 Install the Energy Storage Modules and the Energy Storage Control Unit in sequence. For details, see the floor mounting section.

Figure 4-6 Wall mounting

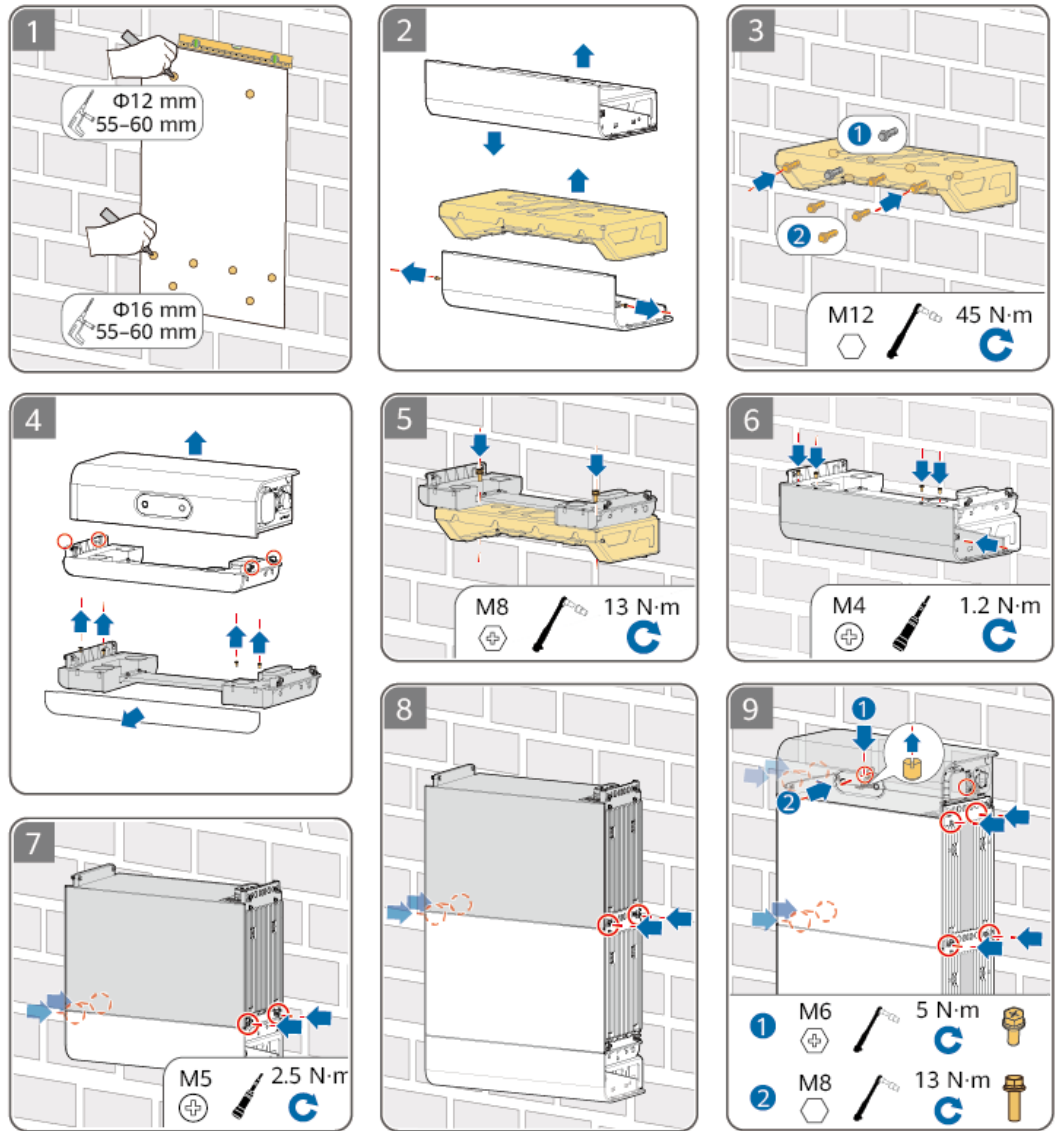

----End

5 Electrical Connections

 **DANGER**

Before connecting cables, ensure that the **DC SWITCH** on the ESS and all switches connected to the ESS are **OFF**. Otherwise, the high voltage of the ESS may result in electric shocks.

 **DANGER**

Note the polarities when installing batteries. Do not connect the positive and negative poles of a battery or battery string together. Otherwise, the battery may be short-circuited.

 **DANGER**

- Do not smoke or have an open flame around batteries.
 - Wear personal protective equipment and use dedicated insulated tools to avoid electric shocks or short circuits.
-

 **WARNING**

- Equipment damage caused by incorrect cable connections is not covered by the product warranty.
 - Only qualified electrical technicians are allowed to connect cables.
 - Operation personnel must wear proper PPE when connecting cables.
-

 **WARNING**

- Tighten the screws on copper bars or cables to the torque specified in this document. Periodically confirm whether the screws are tightened, check for rust, corrosion, or other foreign objects, and clean them up if any. Loose screw connections will result in excessive voltage drops and batteries may catch fire when the current is high.
 - When installing batteries, do not place installation tools, metal parts, or sundries on the batteries. After the installation is complete, clean up the objects on the batteries and the surrounding area.
-

 **CAUTION**

- Do not connect two or more cables to the positive or negative power port of a battery in parallel.
 - Stay away from the equipment when preparing cables to prevent cable scraps from entering the equipment. Cable scraps may cause sparks and result in personal injury and equipment damage.
-

 **NOTE**

The cable colors shown in the electrical connection diagrams provided in this section are for reference only. Select cables in accordance with local cable specifications (green-and-yellow cables are only used for protective earthing).

5.1 Preparing Cables

Figure 5-1 ESS cable connections

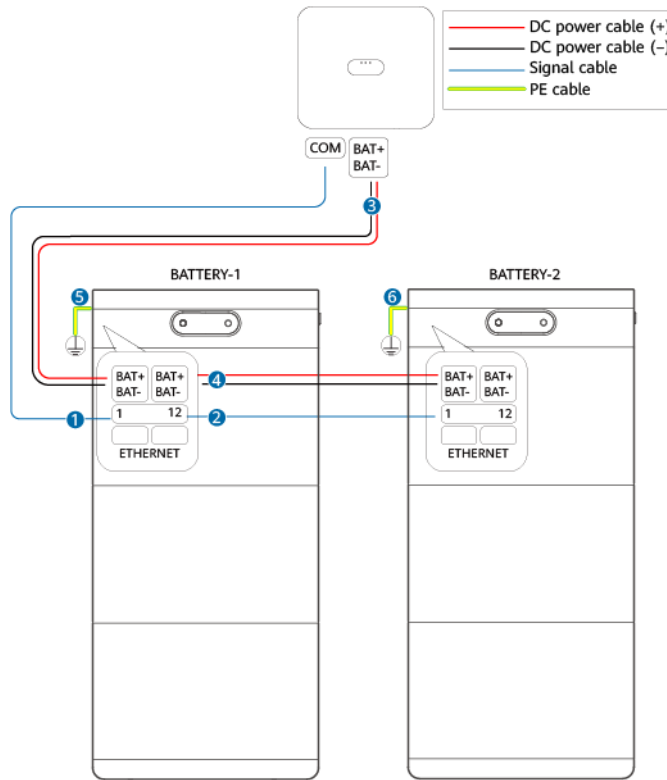

IB02H00016

Table 5-1 Preparing cables

No.	Cable	Type	Recommended Specifications	Source
1 2	Signal cable (between the inverter and an ESS and between ESSs)	Outdoor shielded twisted pair cable (eight-core)	<ul style="list-style-type: none"> Conductor cross-sectional area: 0.20–1 mm² Cable outer diameter: 4–8 mm 	Prepared by the customer
3 4	DC input power cable (between the inverter and an ESS and between ESSs)	Common outdoor PV cable in the industry	<ul style="list-style-type: none"> Conductor cross-sectional area: 4–6 mm² Cable outer diameter: 5.5–9 mm 	Prepared by the customer

No.	Cable	Type	Recommended Specifications	Source
5 6	PE cable	Single-core outdoor copper cable	<ul style="list-style-type: none"> 10 mm² 	Prepared by the customer

 **NOTE**

- The minimum cable cross-sectional area must meet local standards.
- The factors to be considered in cable selection include the rated current, cable type, routing mode, ambient temperature, and maximum acceptable line loss.
- The length of the DC input power cables and signal cables between an ESS and the inverter must be less than or equal to 20 m.

5.2 Cable Hole on the Decorative Cover

NOTICE

The cable hole on the decorative cover is small. Route the cables through the decorative cover before connecting the terminals.

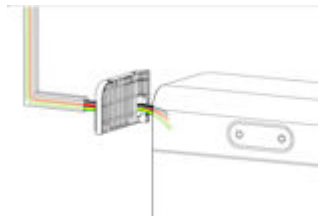

5.3 Installing a PE Cable

Precautions

 **DANGER**

Ensure that the PE cable is securely connected. Otherwise, electric shocks may occur.

 **NOTE**

It is recommended that silicone grease or paint be applied around the ground terminal after the PE cable is connected.

Procedure

Step 1 Crimp an OT terminal.

NOTICE

- Avoid scratching the core wire when stripping a cable.
- The cavity formed after the conductor crimp strip of the OT terminal is crimped must wrap the core wire completely. The core wire must make close contact with the OT terminal.
- Wrap the wire crimping area with heat shrink tubing. The heat shrink tubing is used as an example.
- Use a heat gun carefully to avoid heat damage to the equipment.

Figure 5-2 Crimping an OT terminal

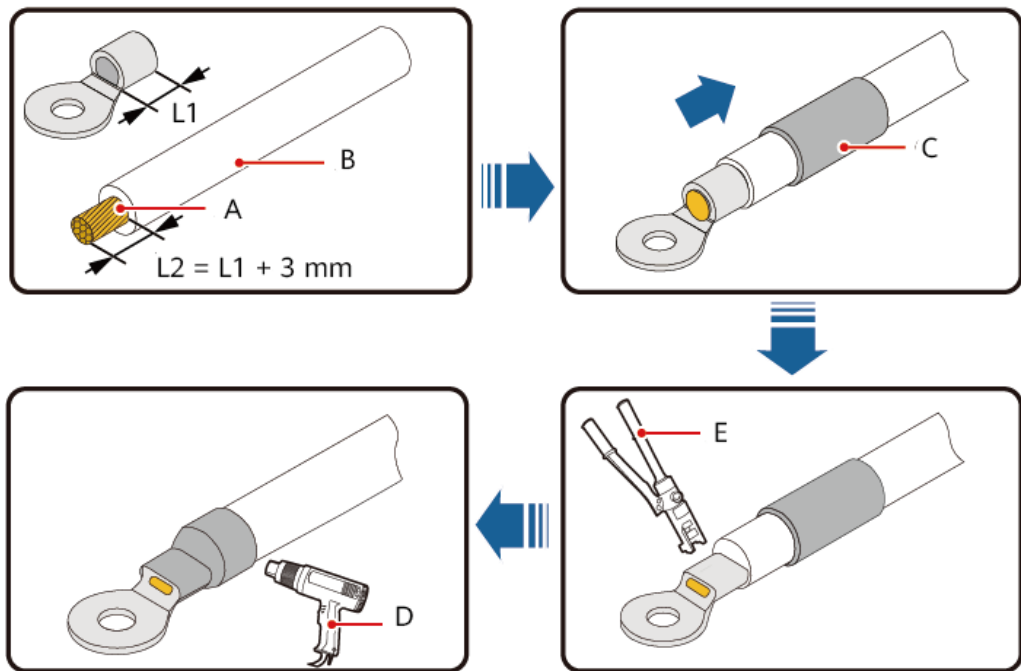

IS05200001

(A) Core wire

(B) Insulation layer

(C) Heat shrink tubing

(D) Heat gun

(E) Hydraulic pliers

Step 2 Connect the ground point of the Energy Storage Control Unit to the external ground point.

Figure 5-3 Connecting the PE cable

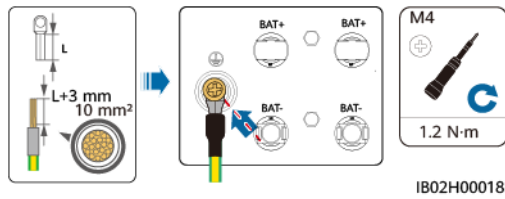

NOTE

Apply silicone grease or paint around the ground terminal after the PE cable is connected.

----End

5.4 Installing DC Input Power Cables

CAUTION

Use the Staubli MC4 positive and negative metal terminals and DC connectors delivered with the product. Using other positive and negative metal terminals and DC connectors may result in serious consequences, such as cable overheating, burning, and module damage. The resulting device damage is not covered by the product warranty.

NOTICE

- Keep the DC input BAT+ cable and BAT- cable close to each other.
- Cables with high rigidity, such as armored cables, are not recommended as DC input power cables, because poor contact may be caused by the bending of the cables.
- When installing the DC input power cables, ensure that the axial tension on DC connectors does not exceed 80 N. Radial stress or torque is not allowed on DC connectors.
- Before assembling DC connectors, label the cable polarities correctly to ensure correct cable connections.
- After crimping the positive and negative metal terminals, pull the DC input power cables back to ensure that they are connected securely.
- Insert the crimped metal terminals of the positive and negative power cables into the appropriate positive and negative connectors. Then pull the DC input power cables back to ensure that they are connected securely.

Connect the DC input power cables to the BAT+ and BAT- terminals of the ESS and the inverter, respectively.

Figure 5-4 Connecting DC input power cables

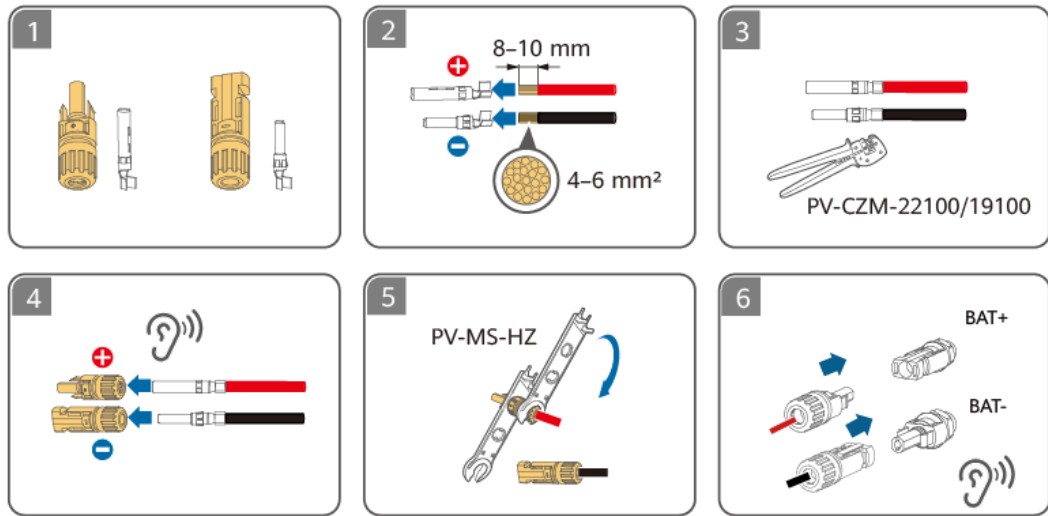

IB02H000019

In a parallel system, connect DC power cables between the ESSs by referring to cable connections between the inverter and an ESS.

5.5 Installing Signal Cables

NOTICE

When laying out signal cables, separate them from power cables and keep them away from strong interference sources to prevent communication interruption.

Signal Port Definition

Figure 5-5 Signal port

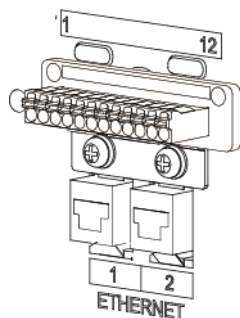

Table 5-2 COM port definition

No.	Label	Definition	Description
1	PE	Shield layer grounding	Shield layer grounding

No.	Label	Definition	Description
2	485A2	RS485A, RS485 differential signal+	Connects to the RS485 signal port+ of the inverter or the ESS in parallel.
3	485B2	RS485B, RS485 differential signal-	Connects to the RS485 signal port- of the inverter or the ESS in parallel.
4	EN	Enable signal+	Connects to the positive enable signal terminal of the inverter or the ESS in parallel.
5	GND	Enable signal GND	Connects to the enable signal GND of the inverter or the ESS in parallel.
6	PE	Shield layer grounding	Shield layer grounding
7	485A2	RS485A, RS485 differential signal+	Connects to the RS485 signal port+ of the inverter or the ESS in parallel.
8	485B2	RS485B, RS485 differential signal-	Connects to the RS485 signal port- of the inverter or the ESS in parallel.
9	EN	Enable signal+	Connects to the positive enable signal terminal of the inverter or the ESS in parallel.
10	GND	Enable signal GND	Connects to the enable signal GND of the inverter or the ESS in parallel.
11	CANH	Extended CAN bus port	Connects to the extended CANH port of the ESS in parallel.
12	CANL	Extended CAN bus port	Connects to the extended CANL port of the ESS in parallel.

Table 5-3 ETHERNET port definition

No.	Label	Definition	Description
1	ETHERNET1	Network cable extension port	Reserved
2	ETHERNET2		

Table 5-4 Signal cable connections

Device	Label
Inverter — ESS	<div style="display: flex; justify-content: space-around; align-items: center;"> <div style="text-align: center;">1 PE</div> <div style="text-align: center;">2 485A2</div> <div style="text-align: center;">3 485B2</div> <div style="text-align: center;">4 EN</div> <div style="text-align: center;">5 GND</div> </div>
ESS — ESS	<div style="display: flex; justify-content: space-around; align-items: center;"> <div style="text-align: center;">6 PE</div> <div style="text-align: center;">7 485A2</div> <div style="text-align: center;">8 485B2</div> <div style="text-align: center;">9 EN</div> <div style="text-align: center;">10 GND</div> <div style="text-align: center;">11 CANH</div> <div style="text-align: center;">12 CANL</div> </div>

Figure 5-6 Signal port connections

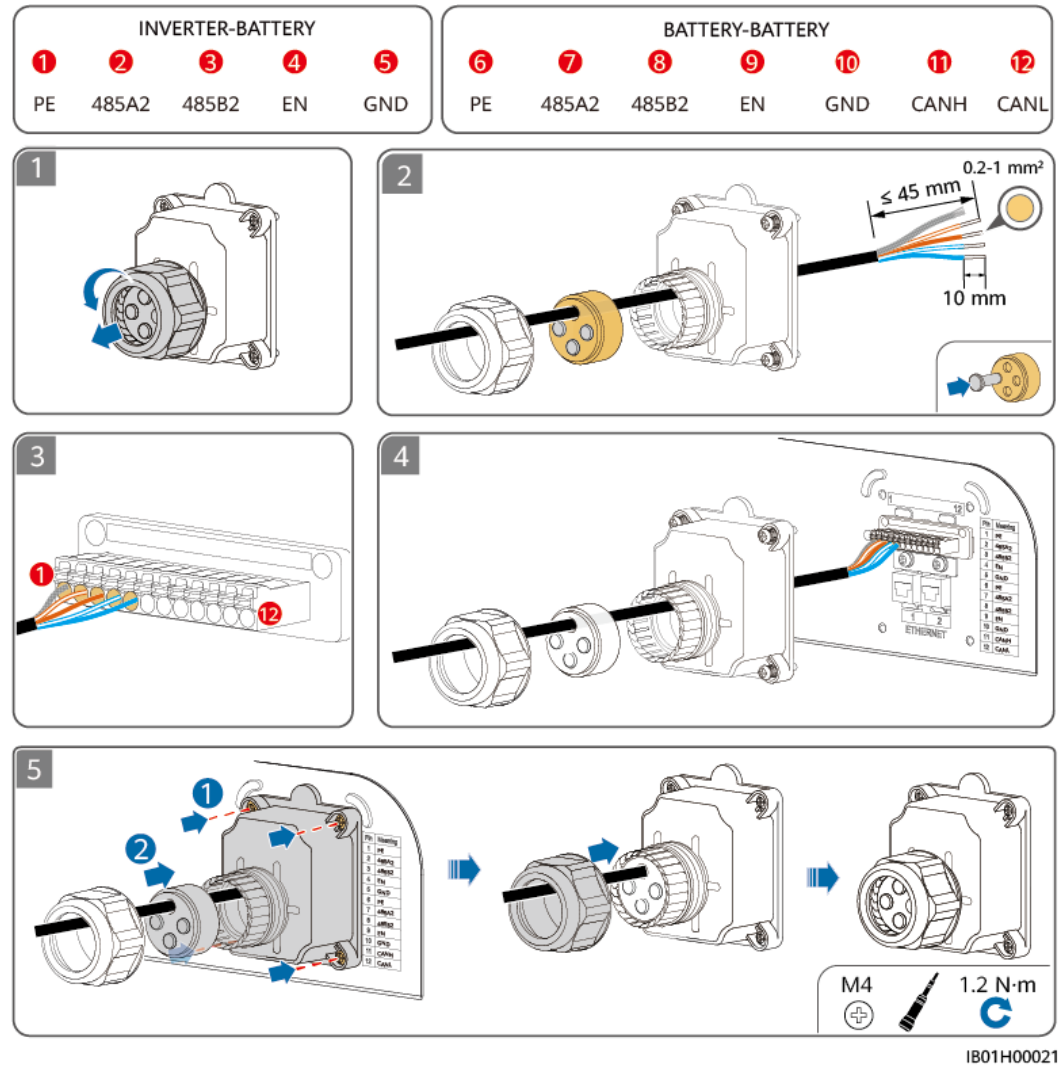

NOTE

Tighten the nut and ensure that the rubber plug is tightly pressed. Otherwise, the waterproof performance will be affected.

Wiring Diagram Example

The following figure shows the cable connections for the SUN2000-(3KTL-10KTL)-M1 and SUN2000-(12K-25K)-MB0.

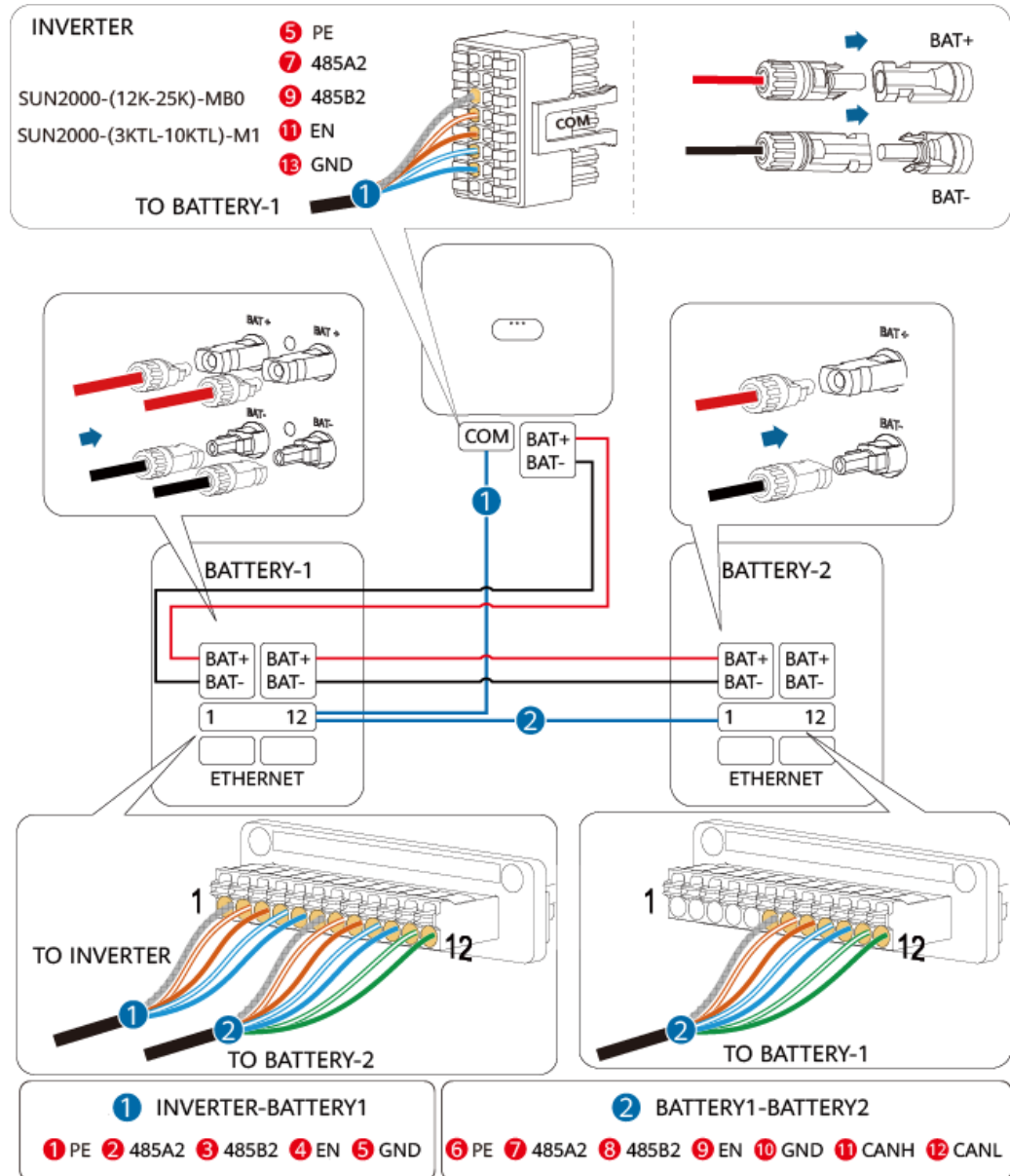

5.6 Installing Decorative Covers

After electrical connections are complete, check that cables are connected correctly and reliably, and then install the external decorative covers.

Figure 5-7 Installing decorative covers

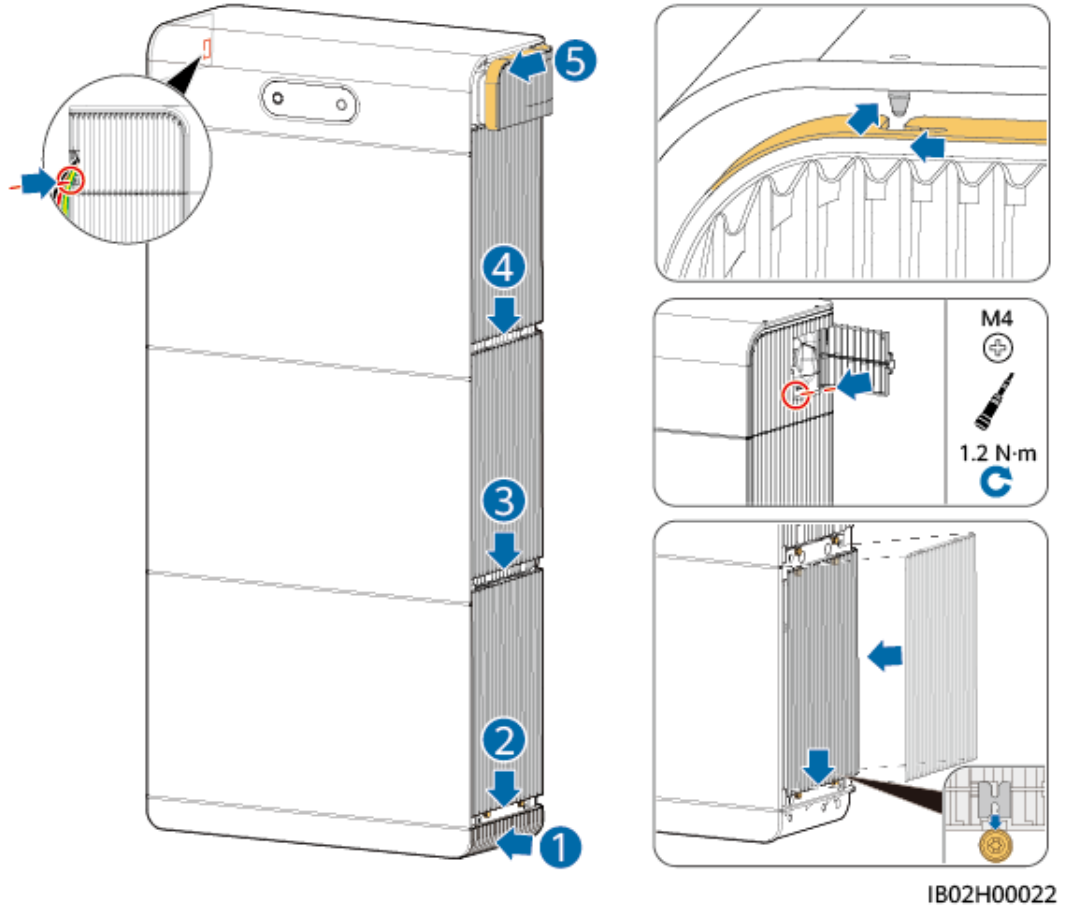

6 Power-On and Commissioning

DANGER

- Wear personal protective equipment and use dedicated insulated tools to avoid electric shocks or short circuits.

CAUTION

- During the power-on procedure, power off the batteries immediately if any fault is detected. Rectify the fault before proceeding with the procedure.
- After batteries are used for system commissioning or batteries have discharged, charge the batteries in time. Otherwise, batteries may be damaged due to overdischarge.
- Battery overdischarge and damage may occur if batteries with low SOC are stored. Batteries shall be recharged in a timely manner.

NOTICE

Before the equipment is put into operation for the first time, ensure that the parameters are set correctly by professional personnel. Incorrect parameter settings may result in noncompliance with local grid connection requirements and affect the normal operations of the equipment.

6.1 Check Before Power-On

Table 6-1 Checklist

No.	Check Item	Expected Result
1	ESS installation	The ESS is installed correctly and securely.

No.	Check Item	Expected Result
2	Cable routing	Cables are routed properly as required by the customer.
3	Cable binding	Cable ties are evenly distributed and no sharp edge exists.
4	Reliable grounding	The PE cable is connected correctly, securely, and reliably.
5	Switch status	The DC SWITCH and all switches connected to the ESS are OFF .
6	Cable connection	DC input power cables, ESS cables, and signal cables are connected correctly and securely.
7	Unused terminal and port	Unused terminals and ports are covered by watertight caps.
8	Installation environment	The installation space is proper, and the installation environment is clean and tidy.

6.2 System Power-On

CAUTION

Power on batteries within 24 hours after unpacking. If the batteries cannot be powered on in time, put them in the original packaging and place them in a dry indoor environment without corrosive gases. During later maintenance, ensure that the power-off time does not exceed 24 hours. Otherwise, the equipment may be damaged.

Power-On Process

- Step 1** Turn on the ESS switch.
- Step 2** At the AC switch between the inverter and the power grid, use a multimeter to measure the grid voltage and ensure that the voltage is within the allowed operating voltage range of the inverter. If the voltage is not in the allowed range, check the circuits.
- Step 3** Turn on the AC switch between the inverter and the power grid.
- Step 4** Turn on the DC switch (if any) between the PV strings and the inverter.
- Step 5** (Optional) Remove the knob locking screw next to the DC switch on the inverter.
- Step 6** Set the DC switch on the inverter to ON.

Step 7 Observe the LED indicators on the inverter and the ESS to check their running status.

----End

Figure 6-1 Power-on process

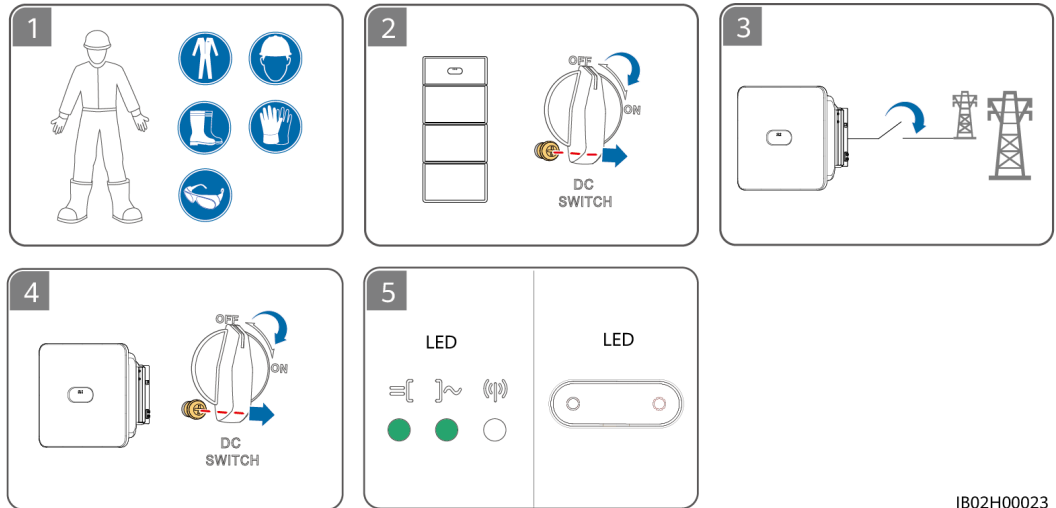

IB02H00023

Indicator Definition

Figure 6-2 Indicator definition

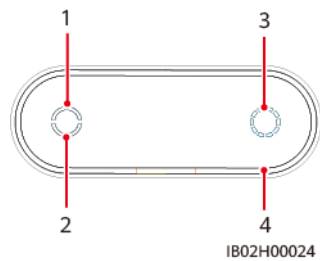

IB02H00024

Table 6-2 Indicator definitions

No.	Indicator
1	Energy Storage Control Unit indicator
2	Energy Storage Module indicator
3	Circular SOC indicator
4	Capsule-shaped indicator

Table 6-3 First power-on indication









First Power-On Indication			
			
Blinking white slowly for three times	Blinking white slowly for three times	SOC displayed after the capsule-shaped indicator blinking for three times	Steady on

Table 6-4 System running indication

Running Indication		
		Meaning
Steady white	Steady white	Operating mode
Blinking white slowly	Blinking white slowly	Standby mode
Off	Off	Hibernation mode
Blinking red fast	N/A	The Energy Storage Control Unit reports an environment alarm.
N/A	Blinking red fast	The Energy Storage Module reports an environment alarm.
Steady red	N/A	The Energy Storage Control Unit is faulty.
N/A	Steady red	The Energy Storage Module is faulty.
ESS Indication		
		Meaning
White	N/A	Average SOC of the ESS
N/A*	Blinking white slowly	The capsule-shaped indicator is pulsating.
N/A	Blinking white fast	Device upgrade and maintenance status
Blinking fast: on for 0.2s and off for 0.2s. Blinking slowly: on for 2s and off for 2s.		

 NOTE

- When the system is being charged or discharged, the circular SOC indicator blinks fast clockwise for two circles at an interval of 1 minute and starts to blink slowly from the third circle and then displays the current SOC. When the last indicator bar is blinking, the system is being charged or discharged.
- When there is no AC input, press the black start button.
 - From 0s to 12s, the indicator status is as described in Table 12-2.
 - From 12s to 2 minutes 13s, the indicator on the left is blinking slowly and the indicator on the right is steady on.
 - Then, the indicator on the left is steady on, and the last bar of the circular SOC indicator is blinking, indicating that the ESS has started charging or discharging.

6.3 ESS Commissioning (Smart Dongle Networking)

6.3.1 Deploying a New Plant

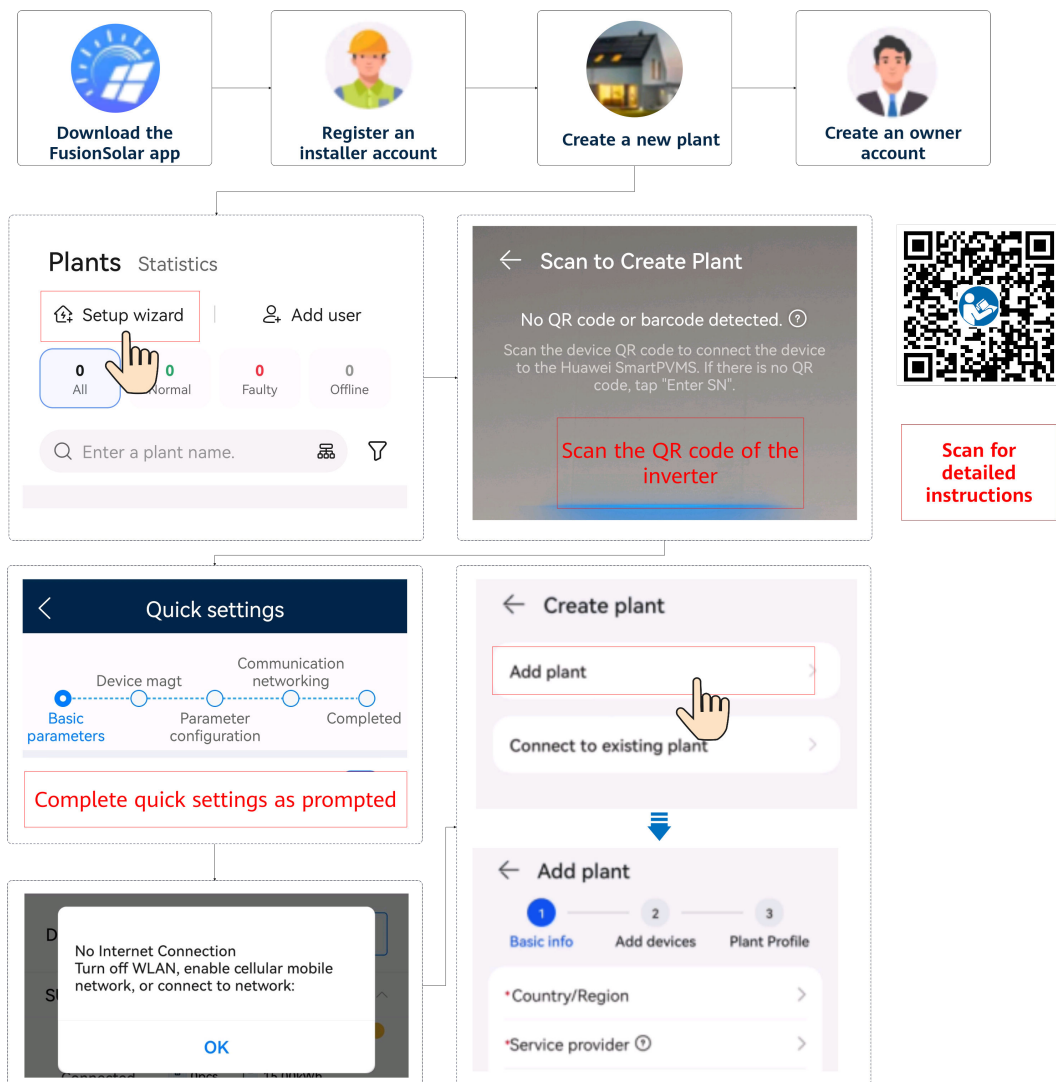

 NOTE

For details about new plant deployment, see the [FusionSolar App Quick Guide](#) or scan the QR code.

Connection Test

Connection Test is supported in quick settings. You can perform this step to check whether the cable connections are correct, avoiding site visits for rectification.

Tap **Connection Test** and wait until the test is complete. If the test fails, rectify the fault in a timely manner.

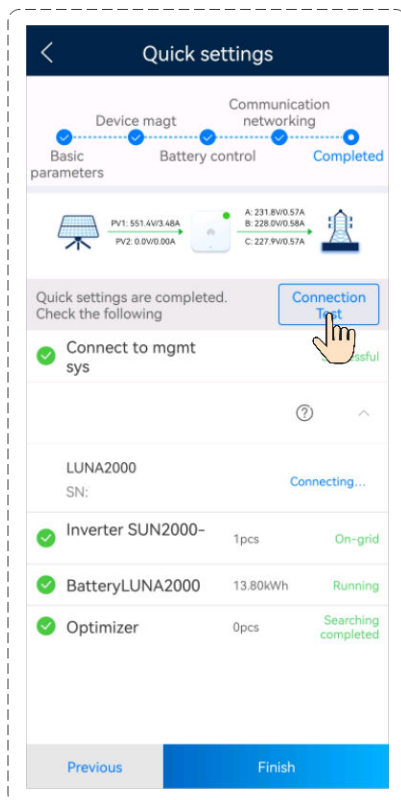

6.3.2 Setting ESS Parameters

Connect the inverter on the app. Choose **Power adjustment** > **Battery control** on the home screen to set related parameters. Set parameters of the ESS connected to each inverter separately.

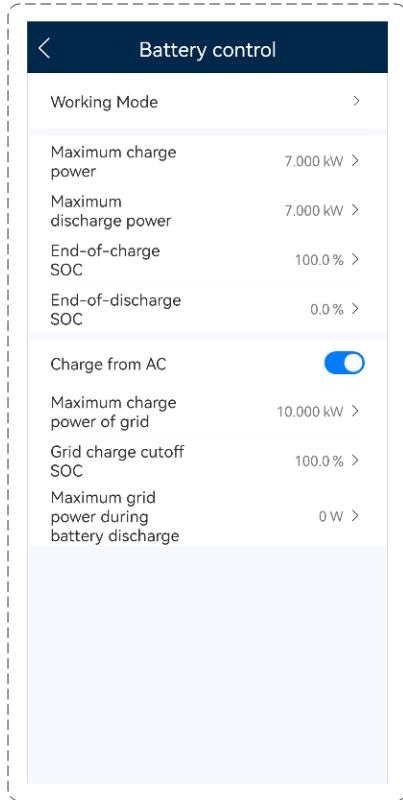

Battery Control

Table 6-5 Battery control parameters

Parameter	Description	Value Range
Working Mode	If this parameter is set to TOU, the system will enable Charge from AC . For details about other settings, see Setting TOU Parameters .	<ul style="list-style-type: none"> Maximum self-consumption TOU Fully fed to grid
Maximum charge power (kW)	Set the maximum charge power of the ESS.	Charge: [0, Maximum charge power]
Maximum discharge power (kW)	Set the maximum discharge power of the ESS.	Discharge: [0, Maximum discharge power]
End-of-charge SOC (%)	Set the end-of-charge SOC.	90%–100%

Parameter	Description	Value Range
End-of-discharge SOC (%)	Set the end-of-discharge SOC. If the battery SOC decreases to 0%, charge the battery in time. Otherwise, the battery capacity will attenuate irreversibly, and the resulting battery fault is not covered by the warranty. You are advised not to set the battery End-of-discharge SOC to 0.	0%–20%
Charge from AC	Charge from AC is disabled by default. After this function is enabled, power can be purchased from the grid. Comply with the grid charge requirements stipulated in local laws and regulations when this function is enabled.	<ul style="list-style-type: none"> • Disabled (default) • Enabled
Maximum charge power of grid	Set the maximum power for charging from the grid.	[0, Maximum charge power of grid]
Grid charge cutoff SOC	Set the grid charge cutoff SOC.	[20%, 100%]
Maximum grid power during battery discharge	When the power purchased from the grid exceeds the preset threshold, the ESS starts discharging. The default value is 0. For example, if this parameter is set to 50 W and the load power is 40 W, 40 W power is purchased from the grid and the ESS does not discharge. If the load power is 100 W, 50 W power is purchased from the grid, and the ESS discharge power is 50 W.	[0, 1000]

 **NOTE**

If no PV modules are installed or the system has not detected sunlight for at least 24 hours, the minimum end-of-discharge SOC is 15%.

Setting TOU Parameters

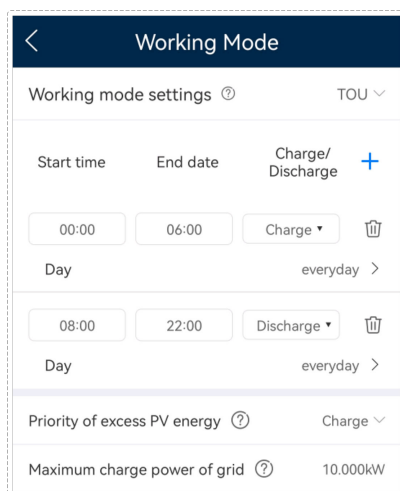

Parameter	Description	Value Range
Priority of excess PV energy	<ul style="list-style-type: none"> Charge: When the PV power is greater than the load power, the surplus PV energy is used to charge the batteries. After the maximum charge power is reached or the batteries are fully charged, the surplus PV energy is fed to the grid. Fed to grid: When the PV power is greater than the load power, the surplus PV energy is preferentially fed to the grid. When the maximum output power of the inverter is reached, the surplus energy is used to charge the batteries. This setting is applicable to the scenario where the feed-in tariff (FIT) is higher than the electricity price. The batteries are used only for backup power. 	<ul style="list-style-type: none"> Charge Fed to grid
Maximum charge power of grid (kW)	Maximum charge power allowed by the grid. The value is determined by the local grid company. If there is no requirement, the value is the maximum charge power of the ESS by default.	[0, Maximum charge power of grid]

6.3.3 Querying the ESS Status

Connect the inverter on the app. Tap **Monitor** on the home screen and tap the ESS icon to view the ESS running status, SOC, power, and charge and discharge status. If an alarm is displayed, see [7.3 Troubleshooting](#).

Figure 6-3 Querying the ESS status

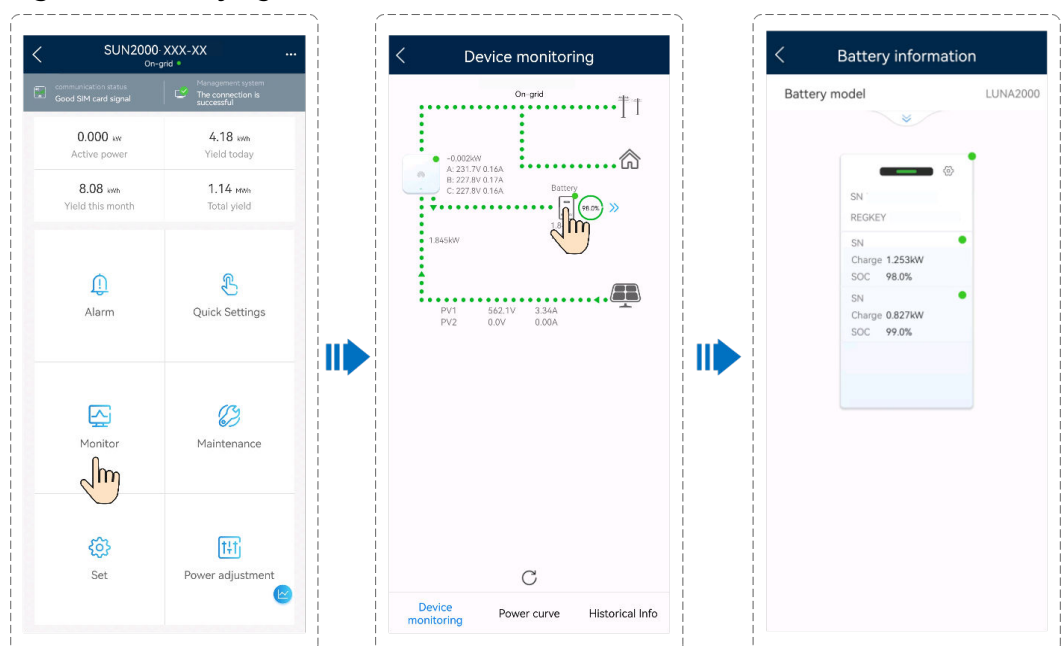

6.3.4 Forced Charge/Discharge

Connect the inverter on the app. Choose **Maintenance** > **Battery maintenance** > **Forced charge/discharge** on the home screen.

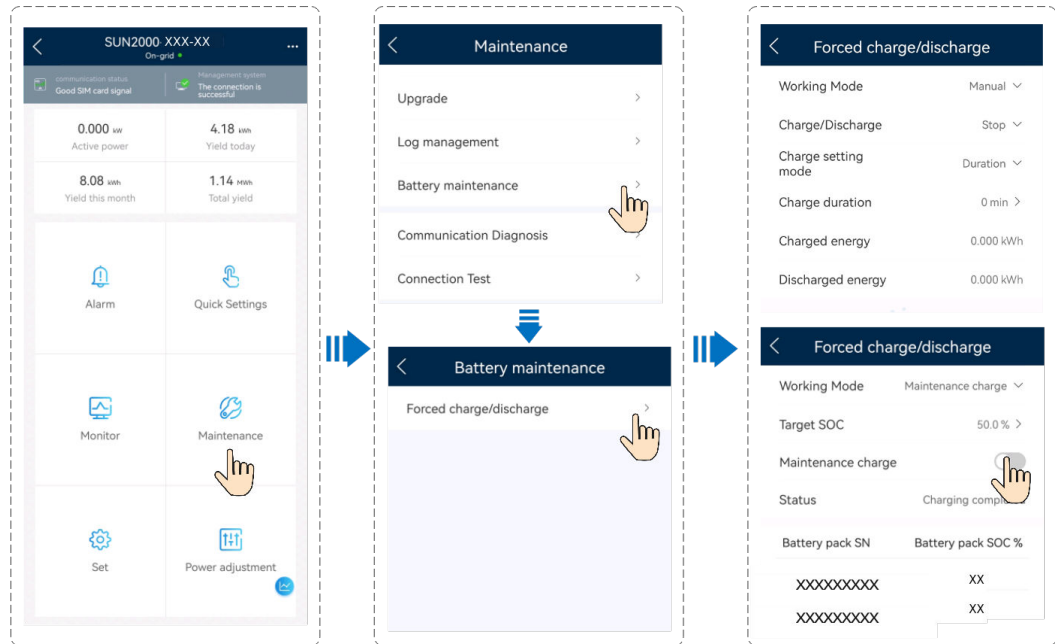

Table 6-6 Description of forced charge/discharge parameters

Mode	Parameter	Description	Value Range
Manual	Charge/Discharge	Specifies whether to charge or discharge the ESS.	<ul style="list-style-type: none"> • Stop • Charge • Discharge
	Charge power/Discharge power (kW)	Specifies the forced charge/discharge power.	<ul style="list-style-type: none"> • Charge: [0, Maximum charge power] • Discharge: [0, Maximum discharge power]
	Charge setting mode/Discharge setting mode	Specifies the charge or discharge mode.	<ul style="list-style-type: none"> • Duration • Energy
	Charge duration/Discharge duration (min)	Specifies the charge or discharge duration.	[0, 1440]
	Charged energy/Discharged energy (kWh)	Specifies the charged or discharged energy. This parameter is not configurable.	-

Mode	Parameter	Description	Value Range
	Remaining time (min)	Specifies the remaining charge or discharge duration. This parameter is not configurable.	-
Main tena nce char ge	Target SOC	Sets the charge target SOC.	[0, 100]
	Maintenance charge	After this function is enabled, the ESS starts charging and stops charging when the target SOC is reached.	Enabled Disabled
	Status	Displays the charging status.	Charging.../Charging completed

6.3.5 ESS Upgrade

ESS Upgrade

Connect the inverter on the app. Choose **Maintenance** > **Upgrade** on the home screen and select the corresponding ESS version.

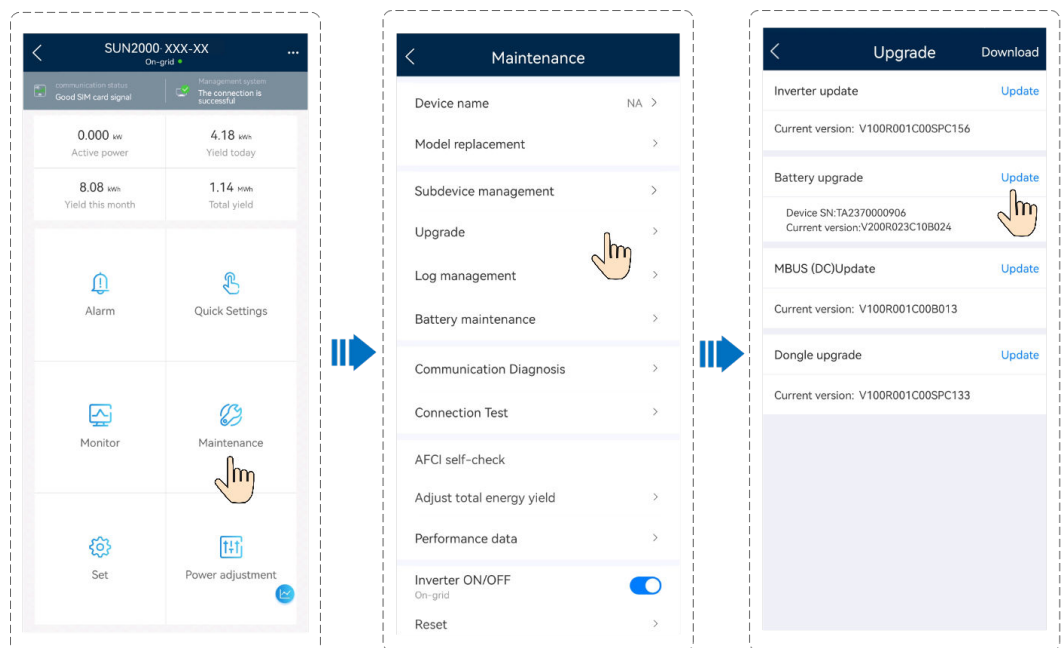

6.3.6 Peak Shaving

Function

This function applies to areas that have peak demand charges. The peak shaving function allows you to lower the peak power drawn from grid in **Maximum self-consumption** or **TOU** mode during peak hours, reducing electricity fees.

NOTE

The peak shaving function cannot be used when the ESS working mode is set to **Fully fed to grid**.

Procedure

1. Log in to the local commissioning screen.
2. Choose **Power adjustment > Peak Shaving**, and set the working mode for peak shaving.

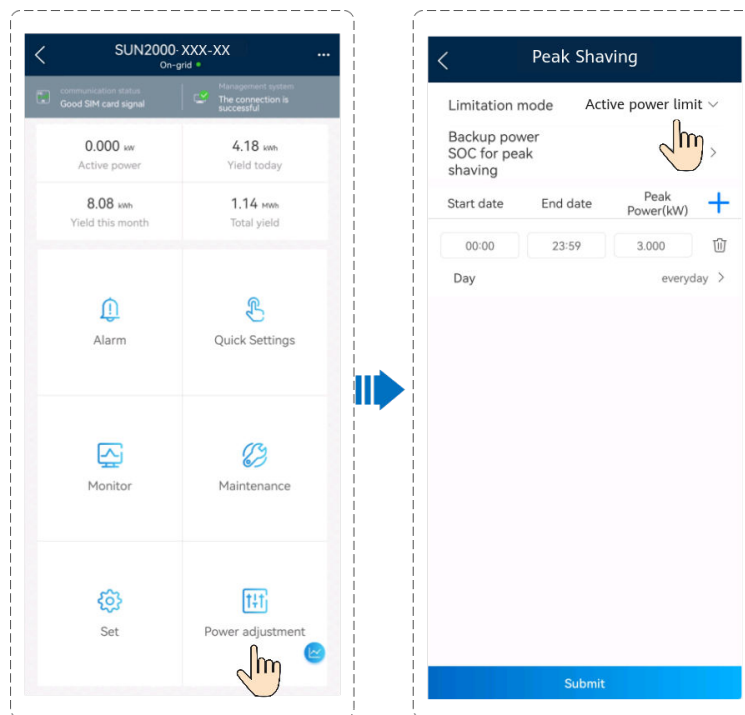

Parameter	Description	Value Range
Peak Shaving	To use Peak Shaving , you need to enable Charge from AC first.	<ul style="list-style-type: none"> • Disabled • Active power limit

Parameter	Description	Value Range
Backup power SOC for peak shaving (%)	The value of this parameter affects the peak shaving capability. A larger value indicates stronger peak shaving capability.	Backup power SOC for peak shaving > Backup power SOC (when Off-grid mode is enabled) > End-of-discharge SOC
Start date	<ul style="list-style-type: none"> Set the peak power range based on the start time and end time. The peak power is configured based on electricity prices in different time segments. You are advised to set the peak power to a low value when the electricity price is high. A maximum of 14 time segments can be set. 	-
End date		
Peak Power (kW)		[0.000, 1000.000]

 NOTE

For details about the peak shaving function, see the [Introduction to Peak Shaving](#).

6.4 ESS Commissioning (EMMA Networking)

6.4.1 Deploying a New Plant

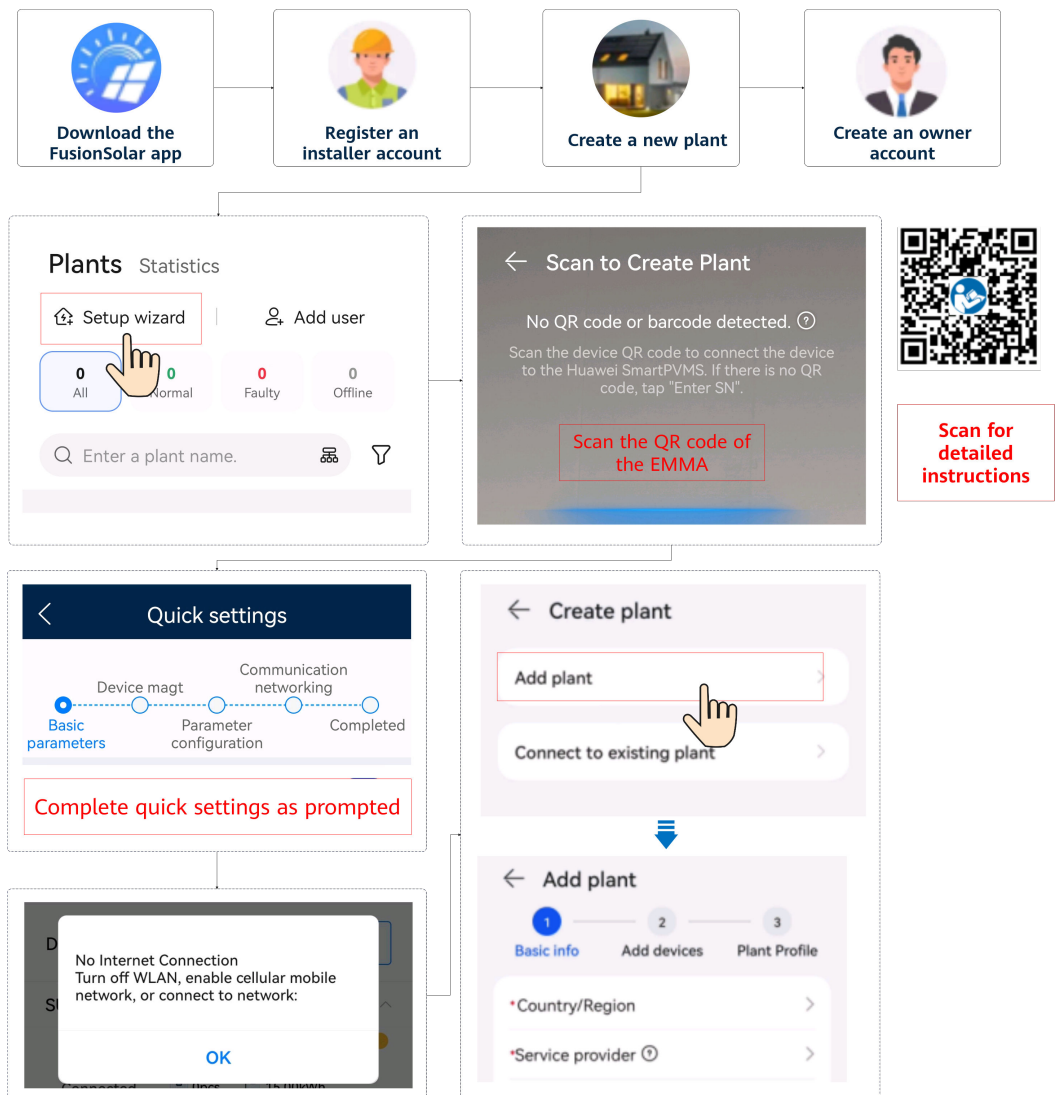

NOTE

For details, see [FusionSolar App Quick Guide \(EMMA\)](#).

Connection Test

Connection Test is supported in quick settings. You can perform this step to check whether the cable connections are correct, avoiding site visits for rectification.

Tap **Connection Test** and wait until the test is complete. If the test fails, rectify the fault in a timely manner.

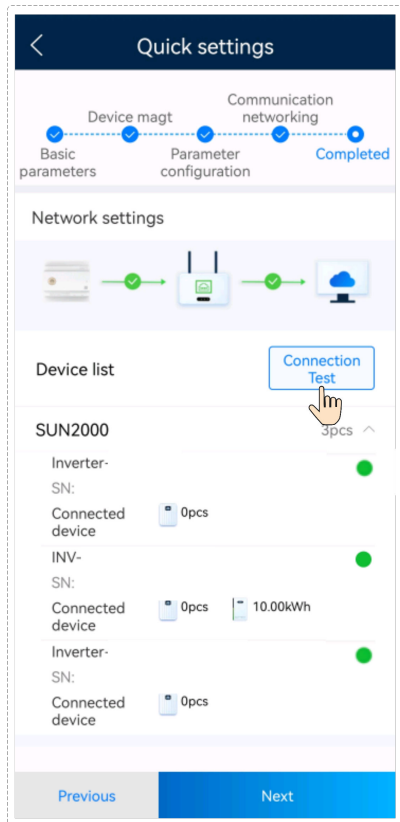

6.4.2 Setting ESS Parameters

Connect the EMMA on the app. Choose **Power adjustment** > **Battery control** on the home screen to set related parameters.

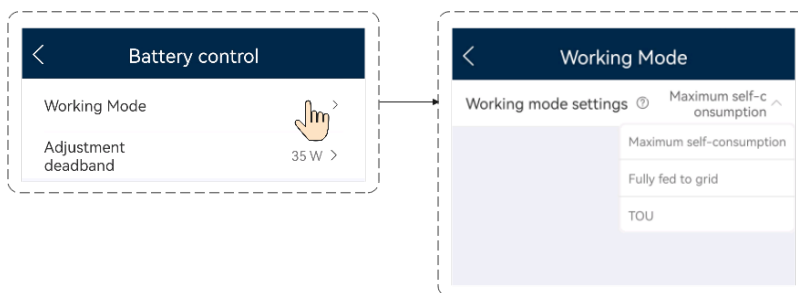

Connect the EMMA on the app. Tap **Monitor** on the home screen, tap the corresponding inverter, tap **Set**, and set related parameters.

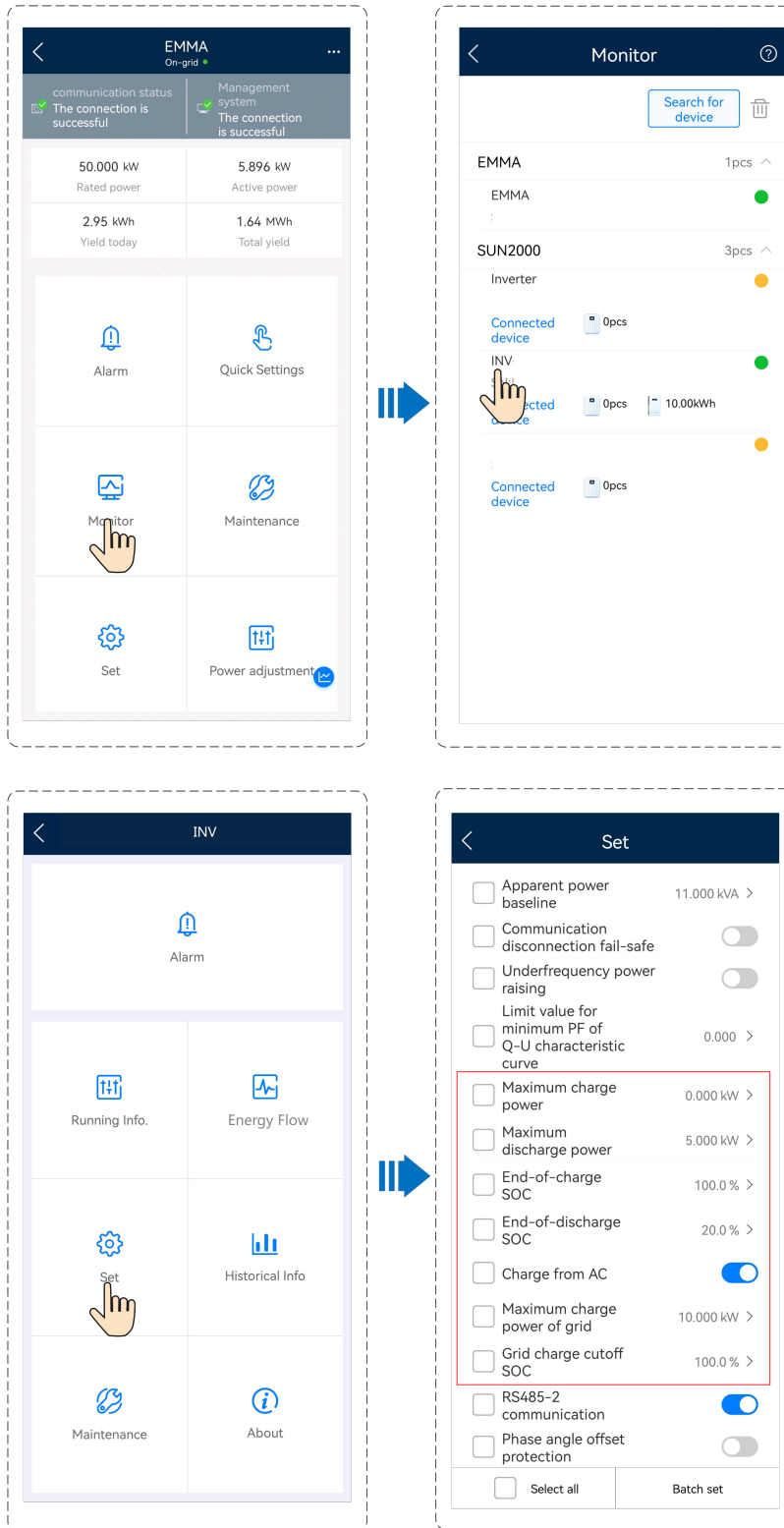

Battery Control

Table 6-7 Battery control parameters

Parameter	Description	Value Range
Working Mode	If this parameter is set to TOU, the system will enable Charge from AC . For details about other settings, see Setting TOU Parameters .	<ul style="list-style-type: none"> Maximum self-consumption TOU Fully fed to grid
Adjustment deadband (W)	The EMMA does not adjust the battery power within the adjustment deadband range.	[0, 35]
Maximum charge power (kW)	Set the maximum charge power of the ESS.	Charge: [0, Maximum charge power]
Maximum discharge power (kW)	Set the maximum discharge power of the ESS.	Discharge: [0, Maximum discharge power]
End-of-charge SOC (%)	Set the end-of-charge SOC.	90%–100%
End-of-discharge SOC (%)	Set the end-of-discharge SOC. If the battery SOC decreases to 0%, charge the battery in time. Otherwise, the battery capacity will attenuate irreversibly, and the resulting battery fault is not covered by the warranty. You are advised not to set the battery End-of-discharge SOC to 0.	0%–20%
Charge from AC	Charge from AC is disabled by default. After this function is enabled, power can be purchased from the grid. Comply with the grid charge requirements stipulated in local laws and regulations when this function is enabled.	<ul style="list-style-type: none"> Disabled (default) Enabled
Maximum charge power of grid	Set the maximum power for charging from the grid.	[0, Maximum charge power of grid]
Grid charge cutoff SOC	Set the grid charge cutoff SOC.	[20%, 100%]
Maximum grid power during battery discharge	When the power purchased from the grid exceeds the preset threshold, the ESS starts discharging. The default value is 0. For example, if this parameter is set to 50 W and the load power is 40 W, 40 W power is purchased from the grid and the ESS does not discharge. If the load power is 100 W, 50 W power is purchased from the grid, and the ESS discharge power is 50 W.	[0, 1000]

 **NOTE**

If no PV modules are installed or the system has not detected sunlight for at least 24 hours, the minimum end-of-discharge SOC is 15%.

Setting TOU Parameters

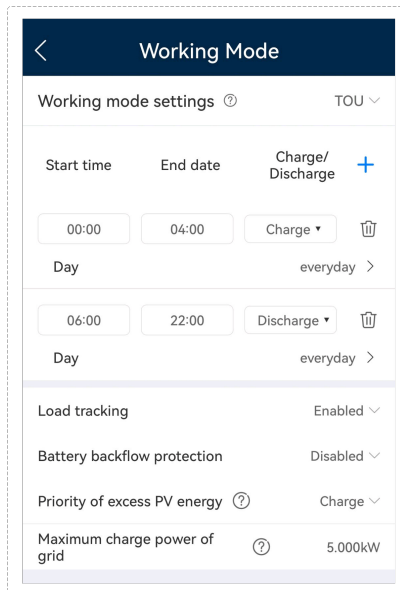

Parameter	Description	Value Range
Priority of excess PV energy	<ul style="list-style-type: none"> Charge: When the PV power is greater than the load power, the surplus PV energy is used to charge the batteries. After the maximum charge power is reached or the batteries are fully charged, the surplus PV energy is fed to the grid. Fed to grid: When the PV power is greater than the load power, the surplus PV energy is preferentially fed to the grid. When the maximum output power of the inverter is reached, the surplus energy is used to charge the batteries. This setting is applicable to the scenario where the feed-in tariff (FIT) is higher than the electricity price. The batteries are used only for backup power. 	<ul style="list-style-type: none"> Charge Fed to grid
Maximum charge power of grid (kW)	Maximum charge power allowed by the grid. The value is determined by the local grid company. If there is no requirement, the value is the maximum charge power of the ESS by default.	[0, Maximum charge power of grid]

6.4.3 Querying the ESS Status

EMMA Networking

Connect the EMMA on the app. Tap **Monitor** on the home screen, tap the corresponding inverter, tap **Connected device**, and tap the ESS icon to view the running status, SOC, power, and charge and discharge status of the ESS. If an alarm is displayed, see [7.3 Troubleshooting](#).

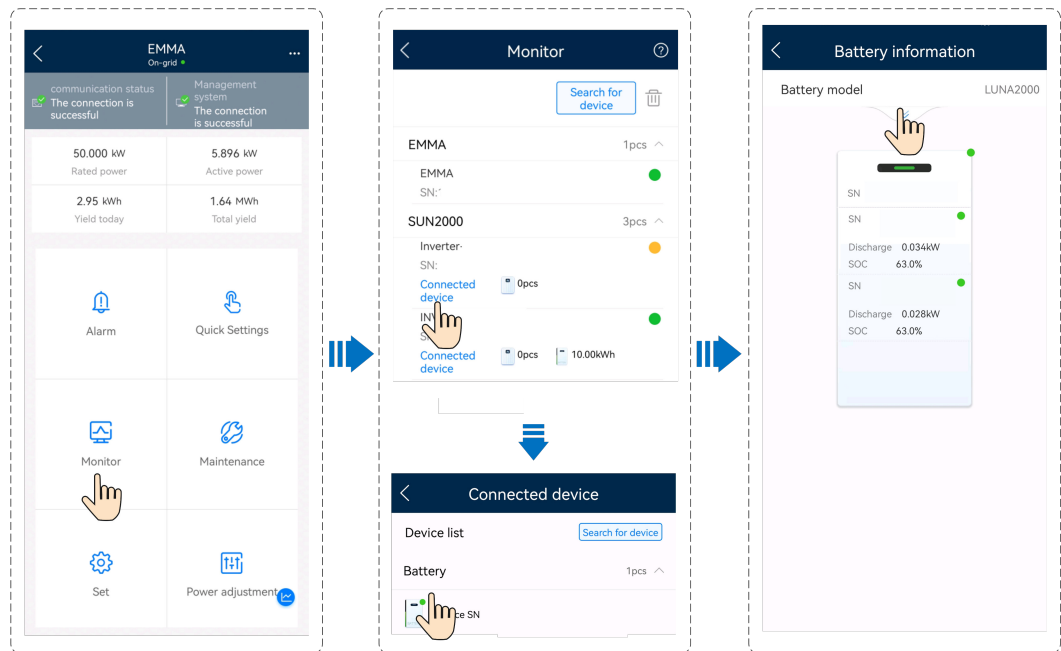

6.4.4 Forced Charge/Discharge

ESS Charge/Discharge

Connect the EMMA on the app. Tap **Monitor** on the home screen, select the corresponding inverter, and choose **Maintenance** > **Battery maintenance** > **Forced charge/discharge**.

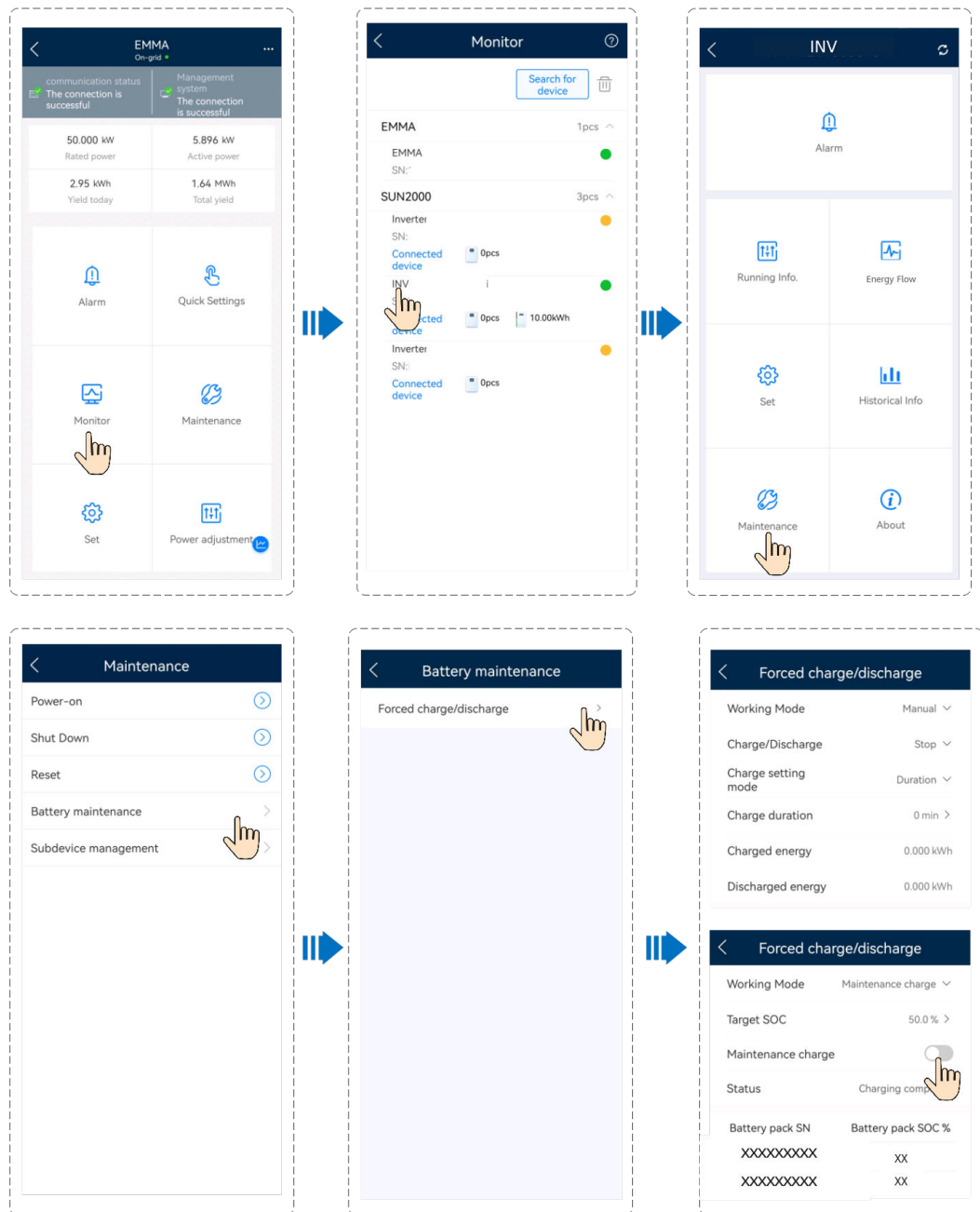

Table 6-8 Description of forced charge/discharge parameters

Mode	Parameter	Description	Value Range
Manual	Charge/Discharge	Specifies whether to charge or discharge the ESS.	<ul style="list-style-type: none"> Stop Charge Discharge

Mode	Parameter	Description	Value Range
	Charge power/Discharge power (kW)	Specifies the forced charge/discharge power.	<ul style="list-style-type: none"> Charge: [0, Maximum charge power] Discharge: [0, Maximum discharge power]
	Charge setting mode/Discharge setting mode	Specifies the charge or discharge mode.	<ul style="list-style-type: none"> Duration Energy
	Charge duration/Discharge duration (min)	Specifies the charge or discharge duration.	[0, 1440]
	Charged energy/Discharged energy (kWh)	Specifies the charged or discharged energy. This parameter is not configurable.	-
	Remaining time (min)	Specifies the remaining charge or discharge duration. This parameter is not configurable.	-
Maintenance charge	Target SOC	Sets the charge target SOC.	[0, 100]
	Maintenance charge	After this function is enabled, the ESS starts charging and stops charging when the target SOC is reached.	Enabled Disabled
	Status	Displays the charging status.	Charging.../Charging completed

6.4.5 ESS Upgrade

ESS Upgrade

[Connect the EMMA on the app](#). Choose **Maintenance > Upgrade** on the home screen and select the corresponding ESS version.

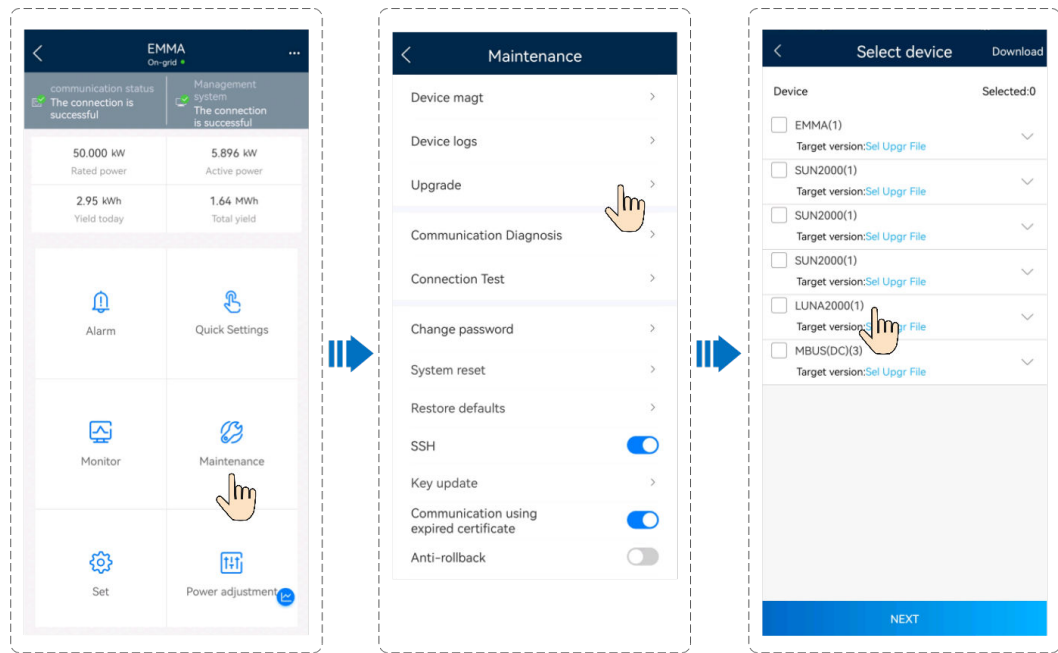

6.4.6 Peak Shaving

Function

This function applies to areas that have peak demand charges. The peak shaving function allows you to lower the peak power drawn from grid in **Maximum self-consumption** or **TOU** mode during peak hours, reducing electricity fees.

NOTE

The peak shaving function cannot be used when the ESS working mode is set to **Fully fed to grid**.

Procedure

1. Log in to the local commissioning screen.
2. Choose **Power adjustment > Peak Shaving**, and set the working mode for peak shaving.

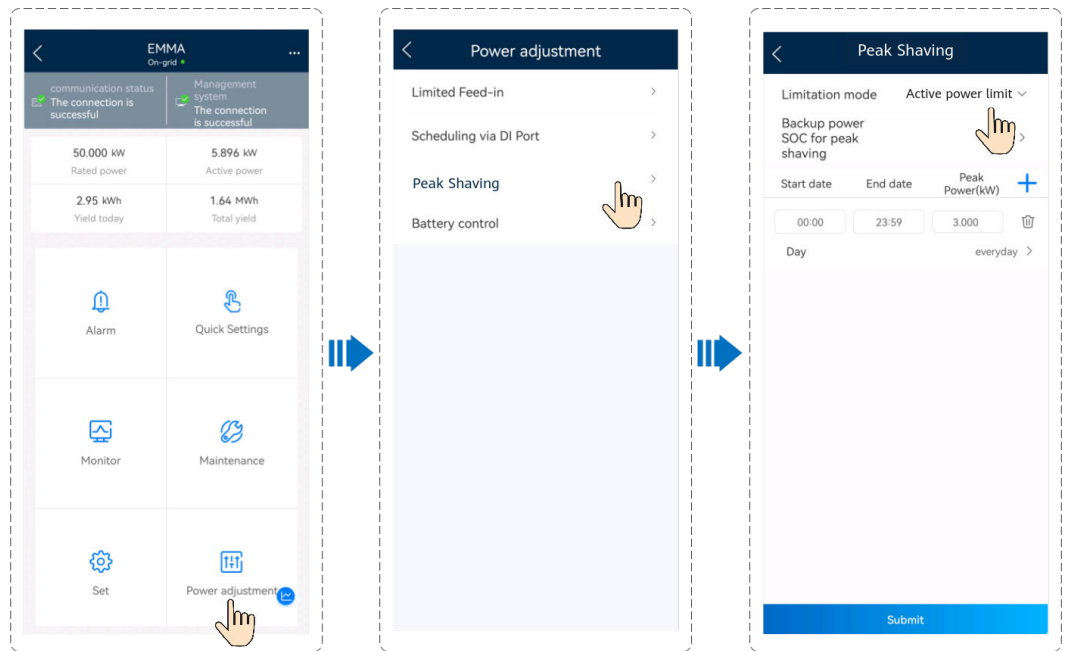

Parameter	Description	Value Range
Peak Shaving	To use Peak Shaving , you need to enable Charge from AC first.	<ul style="list-style-type: none"> No control Active power limit Apparent power limit
Backup power SOC for peak shaving (%)	The value of this parameter affects the peak shaving capability. A larger value indicates stronger peak shaving capability.	Backup power SOC for peak shaving > Backup power SOC (when Off-grid mode is enabled) > End-of-discharge SOC
Start date	<ul style="list-style-type: none"> Set the peak power range based on the start time and end time. The peak power is configured based on electricity prices in different time segments. You are advised to set the peak power to a low value when the electricity price is high. A maximum of 14 time segments can be set. 	-
End date		-
Peak Power (kW)		[0.000, 1000.000]

NOTE

For details about the peak shaving function, see the [Introduction to Peak Shaving](#).

7 ESS Maintenance

DANGER

- Wear personal protective equipment and use dedicated insulated tools to avoid electric shocks or short circuits.
 - Do not smoke or have an open flame around batteries.
 - Do not use wet cloth to clean exposed copper bars or other conductive parts.
 - Do not use water or any solvent to clean batteries.
-

WARNING

- Do not maintain batteries with power on. To power off the batteries before performing operations such as checking and tightening screw torques, explain the risks to the customer, obtain the customer's written consent, and take effective preventive measures.
 - After batteries are discharged, charge them in time to avoid damage due to overdischarge.
 - Before moving or reconnecting the equipment, disconnect the mains and batteries and wait for five minutes until the equipment powers off. Before maintaining the equipment, check that no hazardous voltages remain in the DC bus or components to be maintained by using a multimeter.
-

CAUTION

- Do not connect two or more cables to the positive or negative power port of a battery in parallel.
 - Stay away from the equipment when preparing cables to prevent cable scraps from entering the equipment. Cable scraps may cause sparks and result in personal injury and equipment damage.
-

7.1 System Power-Off

Precautions

⚠ WARNING

- After the system powers off, the remaining electricity and heat may still cause electric shocks and burns. Therefore, wait for 5 minutes after the system is powered off, wear protective gloves, and then perform operations on the ESS. You can maintain the ESS only when all indicators on the ESS are off.
 - When the ESS is running, if you only turn off the DC SWITCH of the ESS, the system is not completely powered off. In this case, do not maintain the ESS.
-

Powering Off the System

- Step 1** Send a shutdown command to the inverter on the app.
- Step 2** Turn off the AC switch between the inverter and the power grid.
- Step 3** Set the **DC SWITCH** at the bottom of the inverter to **OFF**.
- Step 4** (Optional) Install the locking screw for the **DC SWITCH**.
- Step 5** Set the **DC SWITCH** of the ESS to **OFF**.
- Step 6** (Optional) Install the locking screw for the **DC SWITCH** of the ESS.
- Step 7** Turn off the DC switch (if any) between the inverter and PV strings.

----End

7.2 Routine Maintenance

Maintenance Requirements

- To ensure that the ESS operates properly for a long term, you are advised to perform routine maintenance as described in this section.

⚠ CAUTION

Power off the system before cleaning the system, connecting cables, and checking grounding reliability.

Table 7-1 Maintenance checklist

Check Item	Check Method	Maintenance Interval
System cleanliness	<ul style="list-style-type: none"> Check periodically that the heat sinks are free from obstacles and dust. 	Once every 6 to 12 months
System status	<ul style="list-style-type: none"> Check whether the ESS is damaged or deformed. Check whether there is abnormal sound when the ESS is running. Check whether ESS parameters are correctly set when the ESS is running. 	Once every 6 months
Electrical connection	<ul style="list-style-type: none"> Check whether cables are securely connected. Check whether cables are damaged, especially whether the cable sheath that contacts a metal surface is damaged. Check whether unused DC input terminals, ESS terminals, and COM ports are locked by watertight caps. 	6 months after the first commissioning and once every 6 to 12 months after that
Grounding reliability	Check whether the PE cable is securely connected.	6 months after the first commissioning and once every 6 to 12 months after that

7.3 Troubleshooting

NOTE

In this section, the battery power control module refers to the Energy Storage Control Unit and the battery pack refers to the battery expansion module.

Alarm severities are defined as follows:

- Major: The ESS shuts down or some of its functions are abnormal due to a fault.
- Minor: Some components of the ESS are faulty but the ESS can still work.

Table 7-2 Common alarms and troubleshooting measures

Alarm ID	Alarm Name	Severity	Possible Cause	Suggestion
3000	Low battery DC input bus voltage	Major	<ol style="list-style-type: none"> 1. The inverter is faulty and pulls down the bus voltage. 2. The DC bus voltage of the battery is low. 3. The battery DC switch is OFF. 4. The battery cables are not correctly connected. 	<ol style="list-style-type: none"> 1. Check for inverter fault alarms and clear them if any. 2. Turn off the inverter AC output switch, inverter DC input switch, and battery DC switch, and wait for 5 minutes. 3. Check the cable connections to the [Battery-1/2] power control module by referring to the quick installation guide. 4. After checking that the battery power cables are correctly connected, turn on the battery DC switch, AC output switch, and inverter DC input switch in sequence. 5. If the alarm persists, contact the vendor or technical support.
3001	Abnormal battery power control module	Major	<ol style="list-style-type: none"> 1. A major fault has occurred on the internal circuit of the battery power control module. 2. The internal communication of the battery power control module is abnormal. 	<ol style="list-style-type: none"> 1. Turn off the inverter AC output switch, inverter DC input switch, and battery DC switch, and wait for 5 minutes. 2. Turn on the battery DC switch, inverter AC output switch, and inverter DC input switch. 3. If the alarm persists on the [Battery-1/2] power control module (the battery fault indicator is steady on), contact your vendor or technical support.

Alarm ID	Alarm Name	Severity	Possible Cause	Suggestion
3002	Battery power control module overtemperature	Minor	<ol style="list-style-type: none">1. The installation position of the battery power control module is not well ventilated.2. The ambient temperature is excessively high.3. The battery power control module is abnormal.	<ol style="list-style-type: none">1. Check whether the [Battery-1/2] power control module is properly ventilated and whether the ambient temperature exceeds the upper threshold.2. If the ventilation is poor or the ambient temperature exceeds the upper threshold, improve the ventilation and heat dissipation.3. If the ventilation and ambient temperature meet requirements, contact your dealer or technical support.
3003	Battery power control module fuse blown	Major	<ol style="list-style-type: none">1. Battery power control module fuse blown.	<ol style="list-style-type: none">1. Turn off the inverter AC output switch, inverter DC input switch, and battery DC switch, and wait for 5 minutes.2. Replace the fuse of the [Battery-1/2] power control module.3. Turn on the battery DC switch, inverter AC output switch, and inverter DC input switch in sequence. If the alarm persists, contact your dealer or technical support.

Alarm ID	Alarm Name	Severity	Possible Cause	Suggestion
3004	Battery power control module reversely connected	Major	1. The battery power control module is connected to the inverter in reverse polarity.	<ol style="list-style-type: none"> 1. Turn off the inverter AC output switch, inverter DC input switch, and battery DC switch, and wait for 5 minutes. 2. Check the cable connections to the [Battery-1/2] power control module by referring to the quick installation guide. 3. After checking that the battery power cables are correctly connected, turn on the battery DC switch, inverter AC output switch, and inverter DC input switch in sequence. 4. If the alarm persists, contact your dealer or technical support.
3005	Battery power control module DC switch OFF	Warning	<ol style="list-style-type: none"> 1. The DC switch of the battery power control module is OFF. 2. The DC bus cable to the battery power control module is disconnected. 	<ol style="list-style-type: none"> 1. Turn off the inverter AC output switch, inverter DC input switch, and battery DC switch, and wait for 5 minutes. 2. Check the cable connections to the [Battery-1/2] power control module by referring to the quick guide. 3. After checking that the battery power cables are correctly connected, turn on the battery DC switch, inverter AC output switch, and inverter DC input switch in sequence. 4. If the alarm persists, contact your dealer or technical support.

Alarm ID	Alarm Name	Severity	Possible Cause	Suggestion
3006	Abnormal battery expansion module	Major	1. A major fault has occurred on the internal circuit of the battery expansion module.	<ol style="list-style-type: none"> 1. Issue a hibernation command on the app, turn off the inverter AC output switch, inverter DC input switch, and battery DC switch, and wait for 5 minutes. 2. Turn on the battery DC switch, inverter AC output switch, and inverter DC input switch. 3. If the alarm persists, contact the vendor or technical support.

Alarm ID	Alarm Name	Severity	Possible Cause	Suggestion
3007	Battery expansion module cable disconnected	Major	<ol style="list-style-type: none"> 1. The power cable to the battery expansion module is disconnected. 2. The battery expansion module is abnormal. 	<ol style="list-style-type: none"> 1. Turn off the inverter AC output switch, inverter DC input switch, and battery DC switch, and wait for 5 minutes. 2. Check whether the power cable is securely connected to the [Battery-1/2 battery expansion module-1/2/3] (whether the terminal is loose or disconnected, or the cable is disconnected). For details, see the quick installation guide. Method for checking terminal connections: Connect battery expansion modules to the power control module one by one. If all battery expansion modules work properly, the bottom terminals of one or more battery expansion modules are faulty. In this case, exchange the positions of the lowest normal battery expansion module and the battery expansion module at the bottom. If none of the battery expansion modules works properly, replace the power control module. Otherwise, replace the faulty battery expansion module/modules. 3. After checking that the cables are correctly connected, turn on the battery DC switch, inverter AC output switch, and inverter DC input switch in sequence. 4. If the alarm persists, contact the vendor or technical support.

Alarm ID	Alarm Name	Severity	Possible Cause	Suggestion
3008	Battery expansion module overtemperature	Minor	<ol style="list-style-type: none"> 1. The installation position of the battery expansion module is not well ventilated. 2. The ambient temperature is excessively high. 3. The battery expansion module is abnormal. 	<ol style="list-style-type: none"> 1. Check whether the [Battery-1/2 battery expansion module-1/2/3] is properly ventilated and whether the ambient temperature exceeds the upper threshold. 2. If the ventilation is poor or the ambient temperature exceeds the upper threshold, improve the ventilation and heat dissipation. 3. If the ventilation and ambient temperature meet requirements, contact your dealer or technical support.
3009	Battery expansion module low temperature	Minor	<ol style="list-style-type: none"> 1. The ambient temperature is excessively low. 2. A battery expansion module is abnormal. 	<ol style="list-style-type: none"> 1. Check whether the ambient temperature of the [Battery-1/2 battery expansion module-1/2/3] is below the lower threshold. 2. If the ambient temperature is too low, improve the installation environment. 3. If the alarm persists after the ambient temperature becomes normal, contact your dealer or technical support.

Alarm ID	Alarm Name	Severity	Possible Cause	Suggestion
3010	Battery expansion module short circuit	Major	<p>1. The battery expansion module is short-circuited.</p> <p>2. A battery expansion module is abnormal.</p>	<p>1. Turn off the inverter AC output switch, inverter DC input switch, and battery DC switch, and wait for 5 minutes.</p> <p>2. Check whether the power cable (terminal) of the [Battery-1/2 battery expansion module-1/2/3] is correctly connected by referring to the quick installation guide of the product. Method for checking terminal connections: Connect battery expansion modules to the power control module one by one. If all battery expansion modules work properly, the bottom terminals of one or more battery expansion modules are faulty. In this case, exchange the positions of the lowest normal battery expansion module and the battery expansion module at the bottom. If none of the battery expansion modules works properly, replace the power control module. Otherwise, replace the faulty battery expansion module/modules.</p> <p>3. After checking that the cables are correctly connected, turn on the battery DC switch, inverter AC output switch, and inverter DC input switch in sequence.</p> <p>4. If the alarm persists, contact the vendor or technical support.</p>

Alarm ID	Alarm Name	Severity	Possible Cause	Suggestion
3011	Battery expansion module undervoltage	Warning	<ol style="list-style-type: none"> 1. The voltage of a battery expansion module is low. 2. The input voltage of a battery expansion module is low. 	<ol style="list-style-type: none"> 1. If the sunlight is sufficient or AC reverse charging is allowed, the [Battery-1/2 battery expansion module-1/2/3] battery expansion modules can be charged when the inverter is running.
3012	Abnormal battery power control module parallel communication	Major	<ol style="list-style-type: none"> 1. The battery power control modules of the parallel system fail to communicate with each other. 	<ol style="list-style-type: none"> 1. Issue a hibernation command on the app, turn off the inverter AC output switch, inverter DC input switch, and battery DC switch, and wait for 5 minutes. 2. Check that the communications cable is correctly connected between the power control modules in [Battery-1/2] of the parallel system. 3. After checking that the cables are correctly connected, turn on the battery DC switch, inverter AC output switch, and inverter DC input switch in sequence. 4. If the alarm persists, contact the vendor or technical support.

Alarm ID	Alarm Name	Severity	Possible Cause	Suggestion
3013	Abnormal Battery Expansion Module Communication	Major	1. The battery power control module fails to communicate with the battery expansion modules.	<p>1. Turn off the inverter AC output switch, inverter DC input switch, and battery DC switch, and wait for 5 minutes.</p> <p>2. Check that the communications cable (terminal) is correctly connected to [Battery-1/2 battery expansion module-1/2/3]. Method for checking terminal connections: Connect battery expansion modules to the power control module one by one. If all battery expansion modules work properly, the bottom terminals of one or more battery expansion modules are faulty. In this case, exchange the positions of the lowest normal battery expansion module and the battery expansion module at the bottom. If none of the battery expansion modules works properly, replace the power control module. Otherwise, replace the faulty battery expansion module/modules.</p> <p>3. After checking that the cables are correctly connected, turn on the battery DC switch, inverter AC output switch, and inverter DC input switch in sequence.</p> <p>4. If the alarm persists, contact the vendor or technical support.</p>

Alarm ID	Alarm Name	Severity	Possible Cause	Suggestion
3049	Inconsistent Battery Power Control Module Versions	Warning	<ol style="list-style-type: none"> 1. The versions of the power control modules in the parallel system are inconsistent. 2. The update failed. 	<ol style="list-style-type: none"> 1. The version of the power control modules in [Battery-1/2] is inconsistent with that of other power control modules in the parallel system and needs to be updated. 2. If the update fails multiple times, contact your dealer or technical support.
3050	Inconsistent ESS Versions	Warning	<ol style="list-style-type: none"> 1. The version of the battery power control modules is inconsistent with that of the battery packs. 2. The update failed. 	<ol style="list-style-type: none"> 1. The version of the power control modules in [Battery-1/2] is inconsistent with that of the battery packs and needs to be updated. 2. If the update fails multiple times, contact your dealer or technical support.
3051	ESS Version Mismatch	Major	<ol style="list-style-type: none"> 1. The version of the battery power control modules does not match that of the battery packs, which affects the normal operation. 2. The update failed. 	<ol style="list-style-type: none"> 1. The version of the power control modules in [Battery-1/2] does not match that of the battery packs and needs to be updated. 2. If the update fails multiple times, contact your dealer or technical support.
3061	Battery Pack Lifespan Reached	Major	The battery pack has reached its lifespan.	The battery has reached the end of life. Contact a local recycling agency to dispose of it in compliance with local laws and regulations as well as applicable standards.
3063	Battery Power Control Module Certificate Expired	Major	<ol style="list-style-type: none"> 1. The certificate has expired. 2. The system time is incorrectly set. 	<ol style="list-style-type: none"> 1. Apply for a new certificate for [Battery-1/2]. 2. Correct the system time of [Battery-1/2].

Alarm ID	Alarm Name	Severity	Possible Cause	Suggestion
3064	Battery Power Control Module Certificate About to Expire	Warning	<ol style="list-style-type: none"> 1. The certificate is about to expire. 2. The system time is incorrectly set. 	<ol style="list-style-type: none"> 1. Apply for a new certificate for [Battery-1/2]. 2. Correct the system time of [Battery-1/2].
3065	Battery Power Control Module Certificate Invalid	Warning	<ol style="list-style-type: none"> 1. The installed certificate is invalid. 2. The connection to the certificate server is abnormal. 3. The certificate is not within the validity period. 	<ol style="list-style-type: none"> 1. Ensure that the certificate of [Battery-1/2] is correctly installed. 2. Ensure that the certificate server of [Battery-1/2] is properly connected. 3. Ensure that the certificate installed on [Battery-1/2] is within the validity period.

Alarm ID	Alarm Name	Severity	Possible Cause	Suggestion
3066	Abnormal EN Signal on Battery Expansion Module	Warning	<ol style="list-style-type: none"> 1. The EN cable of the battery expansion module is connected to an incorrect port. 2. The battery expansion module is abnormal. 	<ol style="list-style-type: none"> 1. Turn off the inverter AC output switch, inverter DC input switch, and battery DC switch, and wait for 5 minutes. 2. Check whether the EN cable (terminal) is correctly connected to the power control module of [Battery-1/2 Battery expansion module-1/2/3]. Method for checking terminal connections: Connect battery expansion modules to the power control module one by one. If all battery expansion modules work properly, the bottom terminals of one or more battery expansion modules are faulty. In this case, exchange the positions of the lowest normal battery expansion module and the battery expansion module at the bottom. If none of the battery expansion modules works properly, replace the power control module. Otherwise, replace the faulty battery expansion module/modules. 3. After checking that the cables are correctly connected, turn on the battery DC switch, inverter AC output switch, and inverter DC input switch in sequence. 4. If the alarm persists, contact the vendor or technical support.

7.4 ESS Replacement-1

WARNING

- After the system powers off, the remaining electricity and heat may still cause electric shocks and burns. Therefore, wait for 5 minutes after the system is powered off, wear protective gloves, and then perform operations on the ESS. You can maintain the ESS only when all indicators on the ESS are off.
- When the ESS is running, if you only turn off the DC SWITCH of the ESS, the system is not completely powered off. In this case, do not maintain the ESS.

NOTE

If the ESS is connected to the SUN2000-(12K-25K)-MB0 series and you need to replace the ESS or inverter, restore the baud rate to 9600 before powering off the system. Use the FusionSolar app to scan the QR code to connect to the inverter and access the **Communication settings** screen, choose **RS485 Settings > Baud Rate Negotiation > RS485_2 > Baud Rate Negotiation**, and tap **9600**.

Replacing an Energy Storage Control Unit

- Step 1** Before the replacement, power off the system. For details, see [7.1 System Power-Off](#).
- Step 2** Remove the connected communications cables, DC input power cables, and PE cable.
- Step 3** Loosen the screws on both sides of the Energy Storage Control Unit.
- Step 4** Remove the faulty Energy Storage Control Unit.
- Step 5** Install a new Energy Storage Control Unit. For details, see [4 Installing the ESS](#).
- Step 6** Perform deployment commissioning again. For details, see [6 Power-On and Commissioning](#).

----End

Replacing an Energy Storage Module

- Step 1** Before the replacement, power off the system. For details, see [7.1 System Power-Off](#).
- Step 2** Loosen the screws on both sides of the Energy Storage Control Unit.
- Step 3** Remove the Energy Storage Control Unit.
- Step 4** Remove the screws from the folded mounting bracket.
- Step 5** Loosen the screws on both sides of the faulty Energy Storage Module and remove the Energy Storage Module using lifting handles.
- Step 6** Install a new Energy Storage Module. For details, see [4 Installing the ESS](#).

Step 7 Install the Energy Storage Control Unit. For details, see [4 Installing the ESS](#).

Step 8 Perform deployment commissioning again. For details, see [6 Power-On and Commissioning](#).

Step 9 Delete the offline Energy Storage Module on the FusionSolar app.

When the Smart Dongle is used for networking, [connect the inverter on the app](#), choose **Maintenance > Subdevice management** on the home screen, tap the ESS icon, and delete the offline Energy Storage Module.

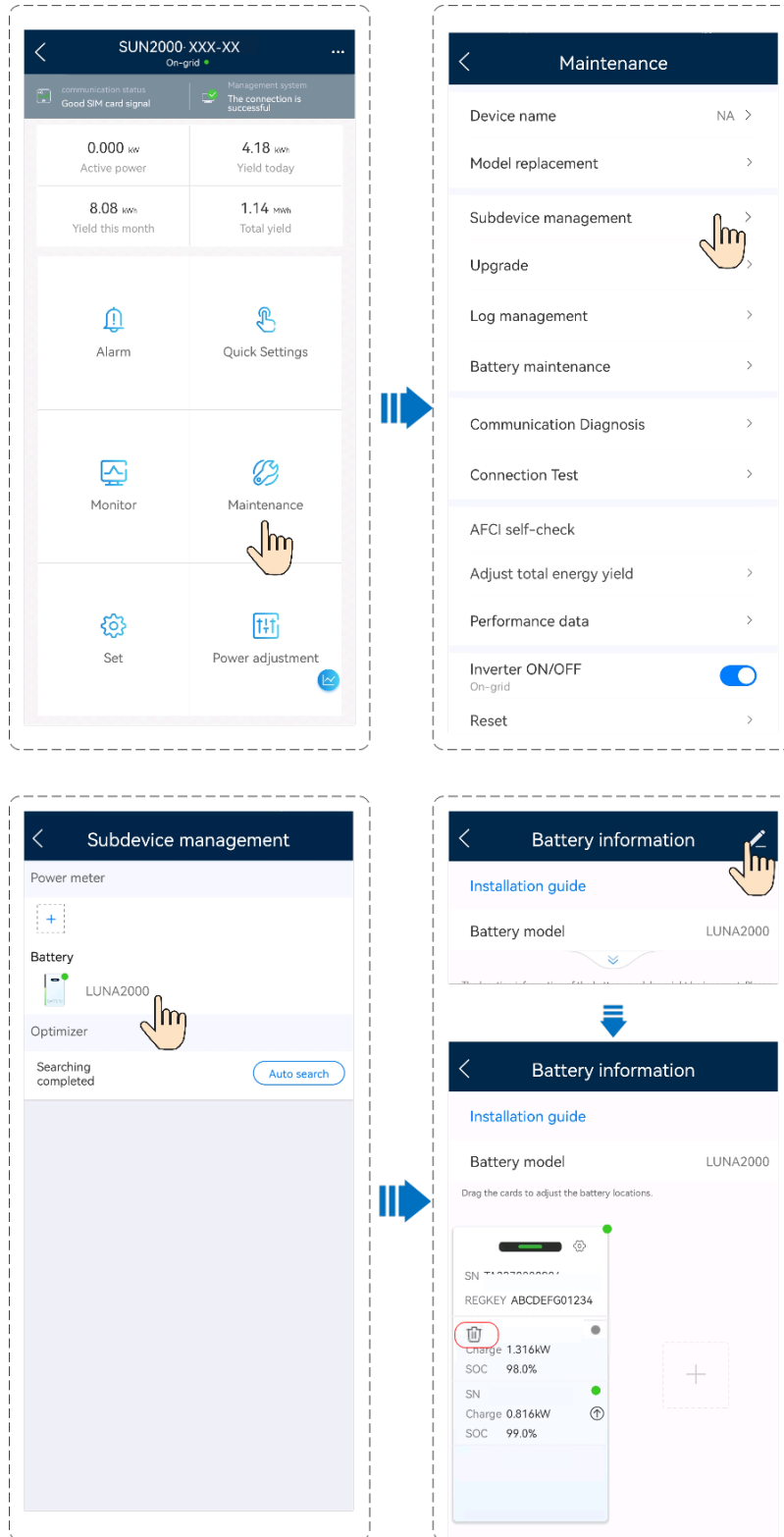

When the EMMA is used for networking, **connect the EMMA on the app**, tap **Monitor** on the home screen, select the connected inverter, choose **Maintenance** > **Subdevice management**, tap the ESS icon, and delete the offline Energy Storage Module.

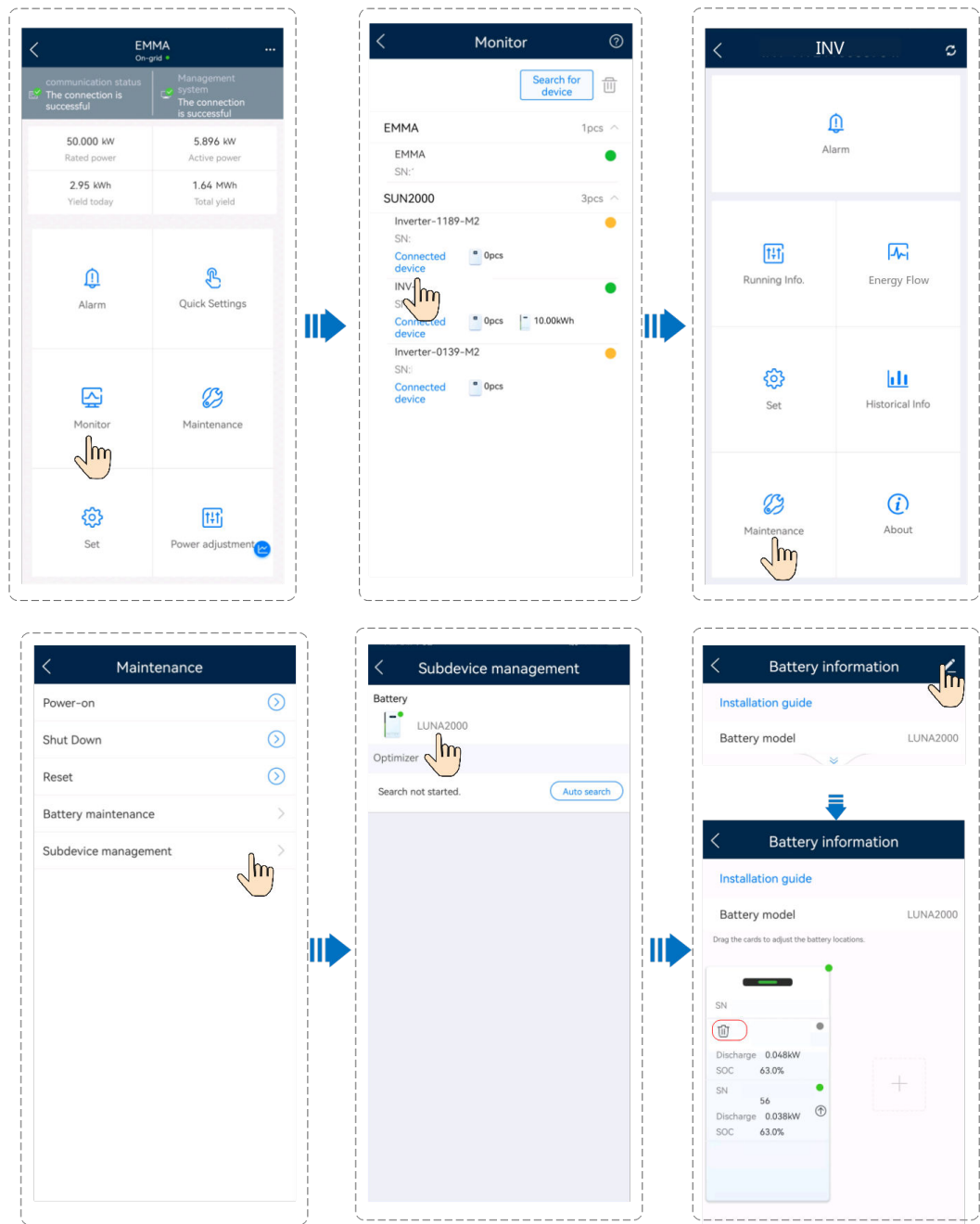

----End

Replacing a Fuse

NOTE

- The fuse inside the Energy Storage Module cannot be replaced separately. This section describes how to replace the fuse of the Energy Storage Control Unit.
- Prerequisite for replacing the fuse: If the inverter is faulty, the fuse is likely to be damaged. In this case, check whether the fuse is damaged. If yes, replace the fuse.

Step 1 Before the replacement, power off the system. For details, see [7.1 System Power-Off](#).

Step 2 Loosen the screws on the fuse enclosure.

Step 3 Open the fuse box, remove the fuse, insert a new fuse into the slot, and close the fuse box. If you hear a click and the raised dots on the sides snap into the box, the fuse is properly installed.

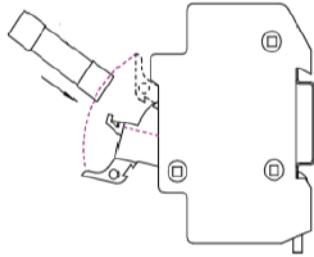

----End

Table 7-3 Fuse specifications

Fuse	Required Specifications		
	Lower Limit	Typical Value	Upper Limit
Category			
Component type	-	Fuse	-
Fuse type	-	Fast blow fuse	-
Rated voltage (V AC/DC)	1100 V DC	-	-
Rated current	38 A	-	-
Breaking capacity	10 kA	-	-
Nominal fusing heat I ² T	600	-	1400
Cold resistance value	-	-	0.005 Ω
Package dimensions (the dimension tolerance shall be specified in the specifications provided by the supplier)	-	14.3 mm x 51 mm	-

Table 7-4 Fuse model

No	Fuse Model	Manufacturer
1	0828040.UXT HP	LITTELFUSE
2	FWL-38A14F	Cooper Xi'An Fusegear
3	RS309- MM-14C43A	Sinofuse Electric

7.5 Charge Requirements for Batteries in Low SOC

After batteries are powered off, static power consumption and self-discharge loss may occur in internal modules. Therefore, charge batteries in a timely manner and do not store batteries in low SOC. Otherwise, the batteries may be damaged due to overdischarge and Energy Storage Modules need to be replaced.

Storing the batteries in low SOC may occur in the following scenarios:

- The DC SWITCH on the Energy Storage Control Unit is OFF.
- The power cables or signal cables are not connected.
- The batteries cannot be charged due to a system fault after discharge.
- The batteries cannot be charged due to incorrect configurations in the system.
- The batteries cannot be charged due to no PV input and long-term mains failure.

Regardless of scenarios, the batteries must be charged within the longest interval corresponding to the SOC when the batteries are powered off. If the batteries are not charged within the specified interval, they may be damaged due to overdischarge.

Power-Off SOC Before Storage	Maximum Charge Interval
SOC \geq 5%	30 days
0% \leq SOC < 5%	7 days

NOTE

- When the battery SOC decreases to 0%, charge the batteries within seven days. Permanent battery faults caused by delayed charge due to customer reasons are not covered by the warranty.
- When the battery SOC is low due to self-discharge loss or extended periods of storage without being charged, the system forcibly charges the batteries to prevent damage from overdischarge. Additionally, in situations where the PV power is insufficient, the system will draw power from the grid regardless of the **Charge from AC** threshold.

7.6 Battery Health Check

- To ensure safe and reliable operation of the ESS, the system checks the state of health (SOH) of batteries. If the SOH decreases to the minimum threshold, the ESS stops working and reports an alarm to avoid safety risks. During battery operation, if the SOH calculation conditions are met, the SOH is checked naturally. If the SOH calculation conditions are not met, the forced check is required.
- Natural check: During normal operation, when batteries are fully charged and then discharge to about 5% to 10% state of charge (SOC) and the batteries are not charged during the discharge, the SOH is checked during this process naturally.

For example, in the maximum self-consumption mode, when the PV power is greater than the load power, the batteries are fully charged to 100% SOC by the surplus PV power. When the PV power is insufficient, the batteries discharge to 5% SOC. The SOH is checked during this process naturally.

- Forced check: The forced check is performed one year after the last SOH check during normal operation or one month after the last SOH check near the end of the battery service life.

Impact of Battery Health Check

- Natural check: Natural checks are performed during normal operation and do not affect the operating status of the ESS.
- In different phases of **Battery Health Check**, the status is displayed as **Detection Request (Requesting calibration)**, **Detecting... (Calibrating...)**, **Pending (Idle)** or **Detection ends (Calibration completed)**. For details, see [6.4.3 Querying the ESS Status](#).
- Forced check: During the forced check, the batteries are charged to 100% SOC, and then immediately discharge until the SOC reaches 0%. Charging is not allowed during discharging. To ensure accurate calculation, the discharging process needs to be completed within 24 hours. In this case, you can increase the load power to shorten the discharging time. If the discharging process exceeds the time limit, the check will fail and then restart 48 hours later. The forced check is performed on an individual battery pack. Only one battery pack can be checked under an inverter at a time. Battery packs under multiple inverters can be checked at the same time. During the forced check, the working mode of the ESS may be changed. For details, see the following table.

Table 7-5 Impact of forced check

ESS Working Mode	Current Charge/Discharge Status	Impact of Forced Check on Charging	Impact of Forced Check on Discharging
TOU	Charging	The ESS working mode is not affected. Batteries are charging at the maximum power.	Batteries are discharging at the current load power (the discharged battery energy cannot be fed to the grid). 1. When the battery discharge power is greater than the load power, the battery discharges and the surplus PV power cannot be fed to the grid. The inverter power is limited, affecting the energy yield. 2. When the battery discharge power is less than the load power, the PV power is supplied to loads at the same time.
	Discharging	Batteries stop discharging and are charging at the maximum power.	
Maximum self-consumption	The PV power is greater than the load power and battery charge power, and the surplus PV power is fed to the grid.	The ESS working mode is not affected. Batteries are charging at the maximum power.	
	The PV power is greater than the load power, and batteries are charging.	Batteries are charging at the maximum power. Power from the grid may be supplied to loads.	
	The PV power is less than the load power, and batteries are discharging.	Batteries stop discharging and are charging at the maximum power. More power from the grid is supplied to loads.	

ESS Working Mode	Current Charge/Discharge Status	Impact of Forced Check on Charging	Impact of Forced Check on Discharging
Fully fed to grid	The PV power is greater than the power limit at the grid-connection point, and batteries are charging.	The batteries are charging at the maximum power, and the feed-in power decreases.	Batteries are discharging at the maximum power, and the total power of PV and batteries is less than the power limit at the grid-connection point. The batteries are fully charged by PV power in the daytime and discharge to less than 5% SOC at night, which meets the natural check conditions. In this working mode, the forced check is rarely performed.
	The PV power is less than the power limit at the grid-connection point, and batteries are discharging.	Batteries stop discharging and are charging at the maximum power. The feed-in power decreases.	

 NOTE

- When the ESS runs in the pure off-grid scenario or in the scenario without PV power, the forced check is not supported.
- When the grid power fails, forced check exits during off-grid switching. If the SOC is lower than the backup power SOC during switching, backup power may be insufficient.
- During the forced check, the system enables **Charge from AC** so that the ESS will obtain power from the grid to fully charge batteries quickly.
- If the ESS or inverter is powered off during the forced check, the check fails and the system does not save the process data. After power-on, the forced check restarts when the conditions are met.

8 Emergency Handling

If an accident (including but not limited to the following) occurs on the site, ensure the safety of onsite personnel first and contact the Company's service engineers.

Battery Falling or Strong Impact

 **DANGER**

If a battery is dropped or violently impacted during installation, it may become faulty and must not be used. Using a faulty battery will cause safety risks such as cell leakage and electric shock.

- If a battery has obvious damage or abnormal odor, smoke, or fire occurs, evacuate the personnel immediately, call emergency services, and contact the professionals. The professionals shall use fire extinguishing facilities to extinguish the fire under safety protection.
- If the appearance is not deformed or damaged, and there is no obvious abnormal odor, smoke, or fire, contact the professionals to transfer the battery to an open and safe place, or contact a recycling company for disposal.

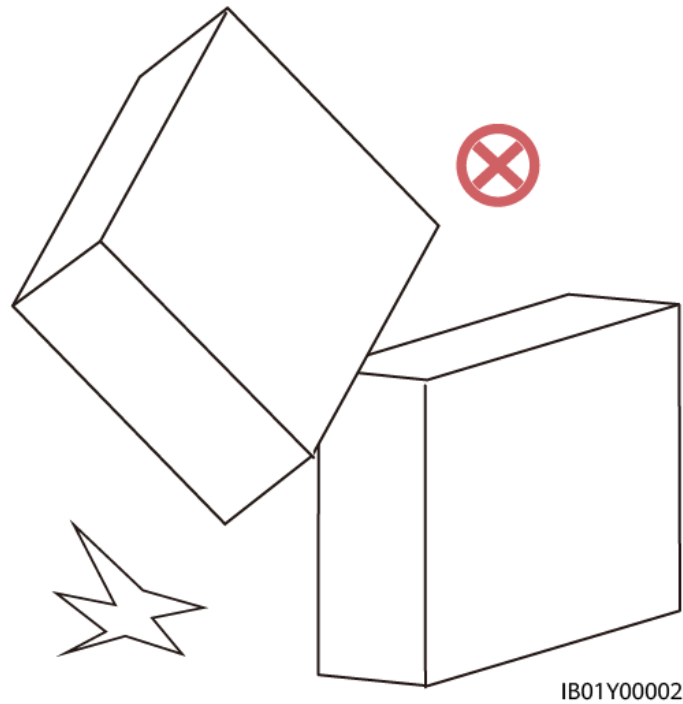

Flood

- Power off the system if it is safe to do so.
- If any part of the batteries is submerged in water, do not touch the batteries to avoid electric shock.
- Do not use batteries that have been soaked in water. Contact a battery recycling company for disposal.

Smoke or Fire

⚠ DANGER

- In case of smoke or fire, if there is a large amount of smoke in the battery storage room, do not open the door to prevent explosion risks and toxic gas inhalation.
 - If a lithium battery catches fire, flammable and toxic gases will be released. Therefore, during the extinguishing process, all firefighters must wear a full set of protective suite, including flame retardant/fireproof clothing, air-purifying respirator or breathing apparatus, firefighter helmet and mask, and insulated shoes.
 - A lithium battery fire may last for several hours. After it is extinguished, the fire may be reignited by the heat generated from residual ingredients due to internal cell damage. After an open flame is extinguished, continue spraying water to cool the batteries. Wait until the battery temperature drops to the room temperature $\pm 10^{\circ}\text{C}$ and monitor for 24 hours to ensure that there is no sign of temperature rise before removing the batteries. Move the removed batteries to a safe place (an open and safe outdoor place is recommended), and then place the batteries in the fire sand box or salt water.
-

If a Huawei ESS emits smoke or catches fire, household members should not dispose of the ESS by themselves. Follow the processes in the flowchart below.

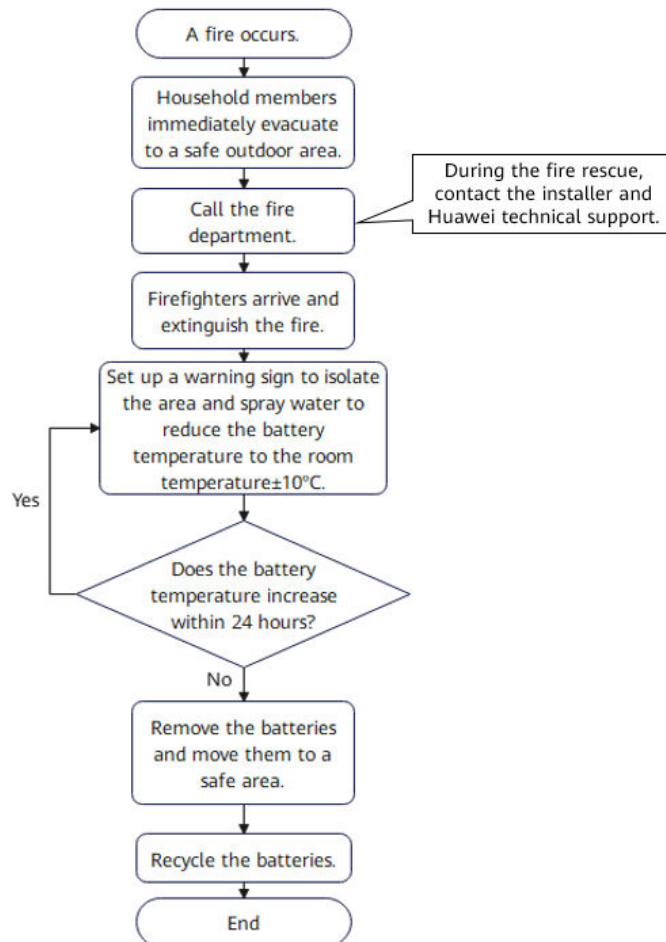

The detailed description is as follows:

1. If batteries emit smoke or catch fires, notify all household members to evacuate immediately.
2. After evacuating to a safe outdoor area (20 m away is recommended), call the fire department immediately. While waiting for the fire rescue, contact the installer and Huawei technical support.
3. Firefighters arrive at the site and extinguish the fire.
4. After the fire is extinguished, set up a warning sign to isolate the area and spray water to reduce the battery temperature to the room temperature $\pm 10^{\circ}\text{C}$. (You can use an infrared thermometer or thermal imager.)
5. Observe the batteries for 24 hours and ensure that there is no sign of temperature rise before removing the batteries. (Only professionals are allowed to remove the batteries.)
6. After removing the batteries, move them to a safe place (an open and safe outdoor place is recommended), place them in the fire sand box or salt water. These operations must be performed by professionals who must take insulation measures, such as wearing insulated gloves, insulated shoes, and personal protective equipment (PPE).

7. After the battery fire is extinguished, if there is no potential risk onsite, the battery must be handled and recycled by professionals in accordance with local laws and regulations.

Electric Shock

DANGER

Before the injured person is separated from the source of electricity, onsite paramedic personnel are not allowed to touch the injured person with their hands to avoid electric shocks.

WARNING

Even if the AC circuit breaker of an inverter is turned off, PV modules and the DC side of the inverter are still energized in the daytime.

For household members, if an electric shock occurs related to a PV device, you are advised to follow the following steps:

- (1) Turn off the AC circuit breaker of the inverter.
- (2) Wear dedicated insulated shoes and insulated gloves, and use insulated tools to separate the injured person from the source of electricity. If no professional equipment is available, you can step on a dry wooden stool or hold insulated tools (such as a long dry wooden stick) to separate the injured person from the source of electricity while ensuring your safety.
- (3) If the injury is serious, call the emergency medical service immediately. Let the injured person lie flat and monitor the person's consciousness, breathing, and heartbeat changes. Personnel who have first aid qualifications or have received first aid training can perform first aid such as artificial respiration and cardiopulmonary resuscitation based on the situation of the injury onsite until the paramedic personnel arrive to send the injured person to the hospital.
- (4) Install warning objects and barricades around the electric shock site to prevent other personnel from getting electric shocks.
- (5) Notify distributors and installers to dispatch professional O&M personnel to rectify the fault.

Battery Leakage

 **DANGER**

- The leaked electrolyte is a colorless viscous liquid that may evaporate rapidly and is flammable, turning into white salt residues. The electrolyte has a pungent smell and is corrosive, irritating to eyes and skin. Avoid contact with it.
- When handling chemical leakage incidents, professional maintenance personnel and firefighters must wear necessary protective equipment such as air-purifying respirator and other PPE.

For household members, if battery leakage occurs, you are advised to follow the following steps:

- (1) Stop the ESS immediately and set the battery switch to OFF. Turn off the AC circuit breaker of the inverter and set the inverter DC switch to OFF.
- (2) Indoor installation scenario: Indoor personnel should quickly evacuate, open the doors, windows, and ventilation devices of the room, and turn off indoor fire sources during the evacuation. Outdoor installation scenario: Notify outdoor personnel to stay away from the site and set up a warning sign to isolate the area.
- (3) After evacuating to a safe area, notify professional maintenance personnel or firefighters to handle the emergency.

Avoid contact with electrolytes or released gases. In the case of contact, take the following measures:

- Inhalation: Evacuate from contaminated areas, get fresh air immediately, and seek immediate medical attention.
- Eye contact: Immediately wash your eyes with water for at least 15 minutes, do not rub your eyes, and seek immediate medical attention.
- Skin contact: Wash the affected areas immediately with soap and water and seek immediate medical attention.
- Intake: Seek immediate medical attention.

Conclusion and Follow-Up Procedure

- After a battery fire is extinguished and there is no potential risk onsite, professionals handle and recycle the batteries after wearing insulated gloves, insulated shoes, and other PPE in accordance with local laws and regulations. After an accident occurs, the manufacturer can identify the damage to the device and replace the device according to the corresponding procedure to restore the ESS.
- After a battery fire is extinguished, the fire extinguishing water may pollute the surrounding soil and water source. In this case, notify the related environmental protection department for evaluation and handling.
- If you have any questions about Huawei residential inverters and ESSs, contact the device distributor and installer. You can also contact us through the local service hotline on Huawei official website.

9 Technical Specifications

Performance			
Energy Storage Control Unit	LUNA2000-10KW-C1		
Number of Energy Storage Control Units	1		
Energy Storage Module	LUNA2000-7-E1		
Energy of an Energy Storage Module ^a	6.9 kWh		
Number of Energy Storage Modules	1	2	3
Available energy of an Energy Storage Module ^a	6.9 kWh	13.8 kWh	20.7 kWh
Maximum output power	3.5 kW	7 kW	10.5 kW
Rated voltage (single-phase system)	450 V		
Operating voltage range (single-phase system)	350–560 V		
Rated voltage (three-phase system)	600 V		

Operating voltage range (three-phase system)	600–980 V		
Communications			
Display	LED		
Communications	RS485/CAN/FE		
General specifications			
ESS weight (including the floor-mounting bracket tool kit)	80 kg	148 kg	216 kg
Dimensions of an Energy Storage Control Unit (W x H x D)	590 mm x 150 mm x 255 mm		
Weight of an Energy Storage Control Unit	10 kg		
Dimensions of an Energy Storage Module (W x H x D)	590 mm x 360 mm x 255 mm		
Weight of an Energy Storage Module	68 kg		
Installation mode	Floor-mounted (standard), wall-mounted (optional)		
Operating temperature	–20°C to +55°C		
Maximum operating altitude	4000 m (derated when the altitude is higher than 2000 m)		
Operating humidity	5%–95%		
Cooling mode	Natural convection		
Ingress protection (IP) rating	IP66		
Cell	LiFePO4		
Note a: The initial capacity (design capacity) of the battery modules is 6.9 kWh. The actual capacity may vary depending on the environment conditions, such as temperature, transportation conditions, and storage conditions.			

A Connecting the Inverter on the App

Step 1 Access the **Commission Device** screen.

Figure A-1 Method 1: before login (not connected to the Internet)

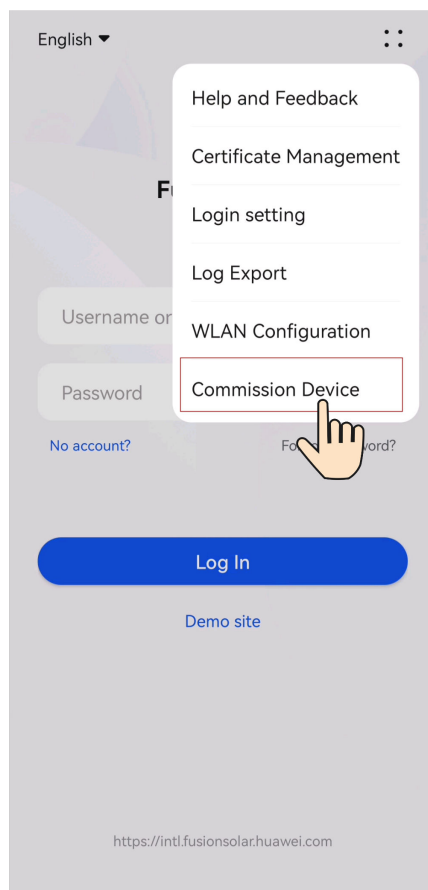
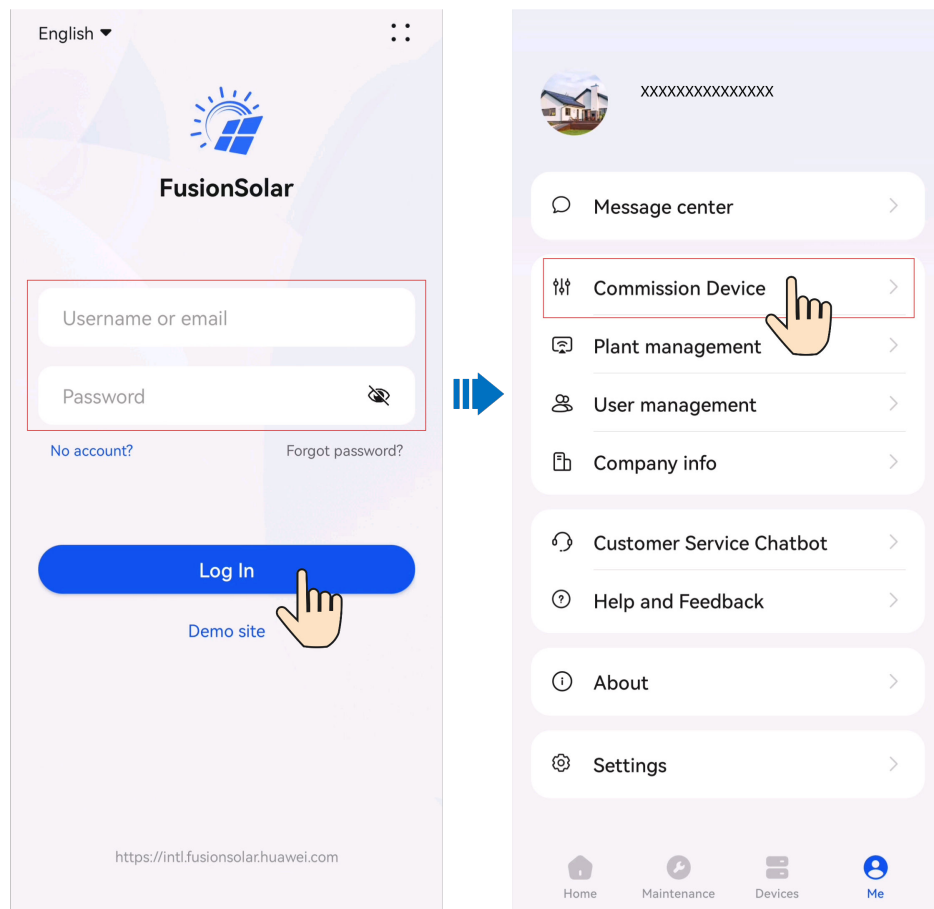
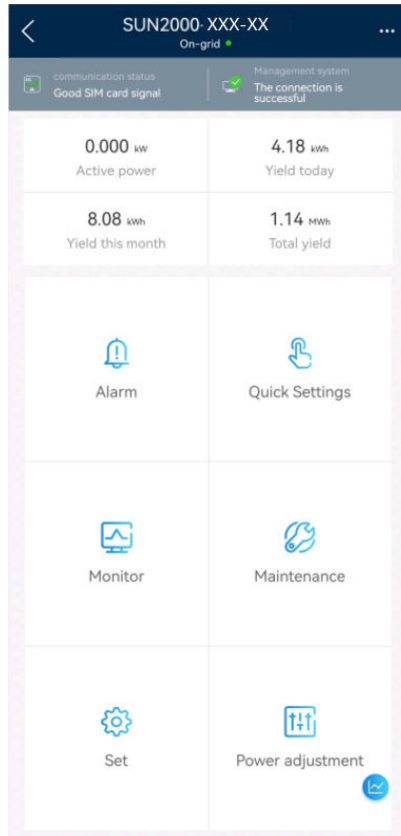

Figure A-2 Method 2: after login (connected to the Internet)



Step 2 Connect to the inverter WLAN, log in as **Installer**, and access the device commissioning screen.



NOTICE

- When directly connecting your phone to a device, ensure that your phone is within the WLAN coverage of the device.
- When connecting the device to the router over WLAN, ensure that the device is within the WLAN coverage of the router and the signal is stable and good.
- The router supports WLAN (IEEE 802.11 b/g/n, 2.4 GHz) and the WLAN signal reaches the inverter.
- The WPA, WPA2, or WPA/WPA2 encryption mode is recommended for routers. The Enterprise mode is not supported (such as airport WLAN and other public hotspots that require authentication). WEP and WPA TKIP are not recommended because they have serious security vulnerabilities. If the access fails in WEP mode, log in to the router and change the encryption mode of the router to WPA2 or WPA/WPA2.

 **NOTE**

- The last six digits of the product WLAN name are the same as the last six digits of the product SN.
- For the first connection, log in with the initial password. You can obtain the initial password from the label on the device.
- To ensure account security, protect the password by changing it periodically, and keep it secure. Your password might be stolen or cracked if it is left unchanged for extended periods. If a password is lost, devices cannot be accessed. In these cases, the Company shall not be liable for any loss.
- If the login screen is not displayed after you scan the QR code, check whether your phone is correctly connected to the device WLAN. If not, manually select and connect to the WLAN.
- If the **This WLAN network has no Internet access. Connect anyway?** message is displayed when you connect to the built-in WLAN, tap **CONNECT**. Otherwise, you cannot log in to the system. The actual UI and messages may vary with mobile phones.

----End

B Connecting the EMMA on the App

Step 1 Access the **Commission Device** screen.

Figure B-1 Method 1: before login (not connected to the Internet)

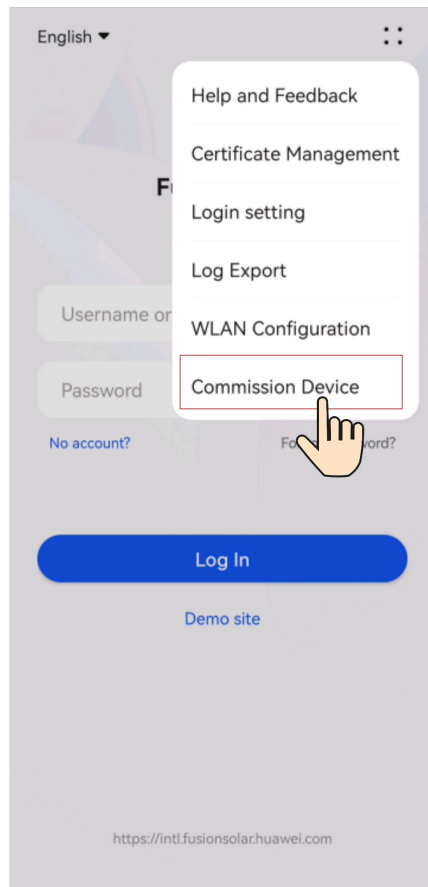
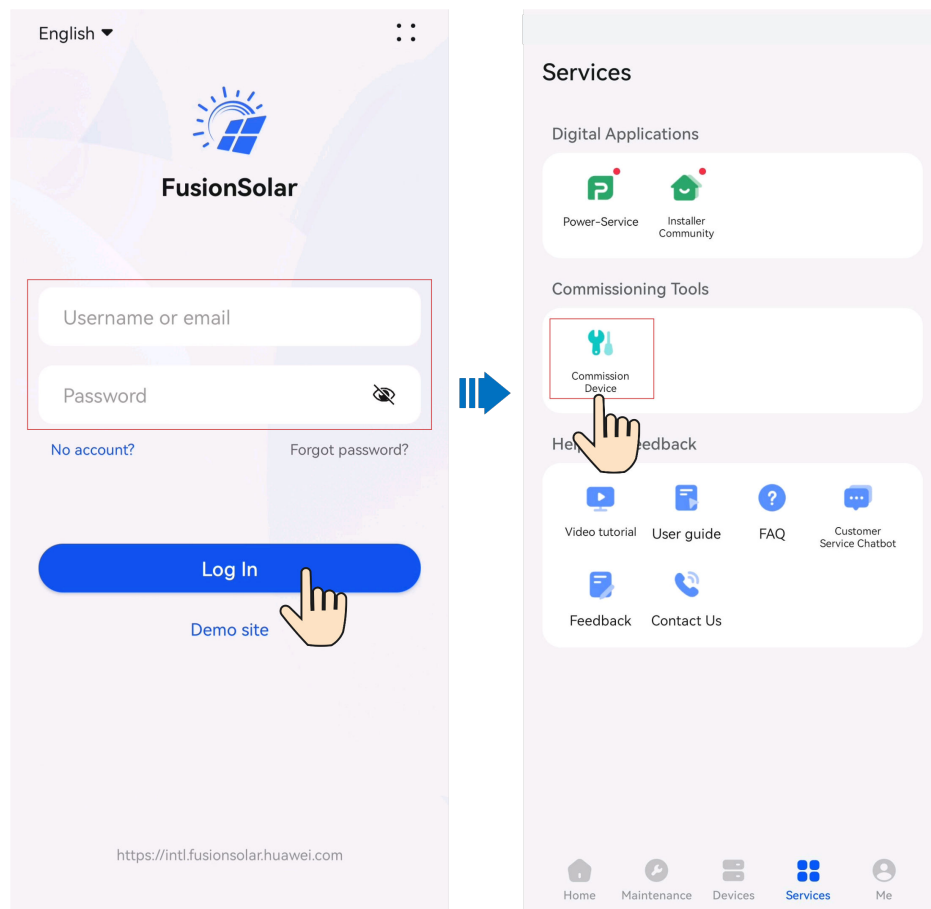
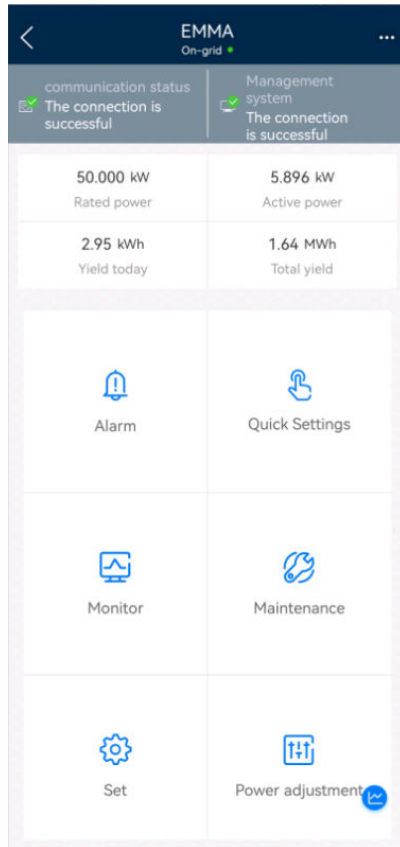

Figure B-2 Method 2: after login (connected to the Internet)



Step 2 Connect to the EMMA WLAN, log in as **Installer**, and access the device commissioning screen.



NOTICE

- When directly connecting your phone to a device, ensure that your phone is within the WLAN coverage of the device.
- When connecting the device to the router over WLAN, ensure that the device is within the WLAN coverage of the router and the signal is stable and good.
- The router supports WLAN (IEEE 802.11 b/g/n, 2.4 GHz) and the WLAN signal reaches the inverter.
- The WPA, WPA2, or WPA/WPA2 encryption mode is recommended for routers. The Enterprise mode is not supported (such as airport WLAN and other public hotspots that require authentication). WEP and WPA TKIP are not recommended because they have serious security vulnerabilities. If the access fails in WEP mode, log in to the router and change the encryption mode of the router to WPA2 or WPA/WPA2.

 **NOTE**

- The last six digits of the product WLAN name are the same as the last six digits of the product SN.
- For the first connection, log in with the initial password. You can obtain the initial password from the label on the device.
- To ensure account security, protect the password by changing it periodically, and keep it secure. Your password might be stolen or cracked if it is left unchanged for extended periods. If a password is lost, devices cannot be accessed. In these cases, the Company shall not be liable for any loss.
- If the login screen is not displayed after you scan the QR code, check whether your phone is correctly connected to the device WLAN. If not, manually select and connect to the WLAN.
- If the **This WLAN network has no Internet access. Connect anyway?** message is displayed when you connect to the built-in WLAN, tap **CONNECT**. Otherwise, you cannot log in to the system. The actual UI and messages may vary with mobile phones.

----End

C Preconfigured Certificate Disclaimer

The Huawei-issued certificates preconfigured on Huawei devices during manufacturing are mandatory identity credentials for Huawei devices. The disclaimer statements for using the certificates are as follows:

1. Preconfigured Huawei-issued certificates are used only in the deployment phase, for establishing initial security channels between devices and the customer's network. Huawei does not promise or guarantee the security of preconfigured certificates.
2. The customer shall bear consequences of all security risks and security incidents arising from using preconfigured Huawei-issued certificates as service certificates.
3. A preconfigured Huawei-issued certificate is valid from the manufacturing date until December 29, 2099.
4. Services using a preconfigured Huawei-issued certificate will be interrupted when the certificate expires.
5. It is recommended that customers deploy a PKI system to issue certificates for devices and software on the live network and manage the lifecycle of the certificates. To ensure security, certificates with short validity periods are recommended.

NOTE

You can view the validity period of a preconfigured certificate on the network management system.

D Acronyms and Abbreviations

A	European Agreement Concerning the International Carriage of Dangerous Goods by Road
ADR	
APP	application
AC	alternating current
B	battery
BAT	
D	
DC	direct current
F	
FIT	feed-in tariff
G	ground
GND	
I	
IMDG	International Maritime Dangerous Goods
P	
PV	photovoltaic
PE	protecting earthing
PPE	personal protective equipment
S	state of charge
SOC	state of health
SOH	serial number
SN	
T	

TOU	time of use
W	wireless local area network
WLAN	